

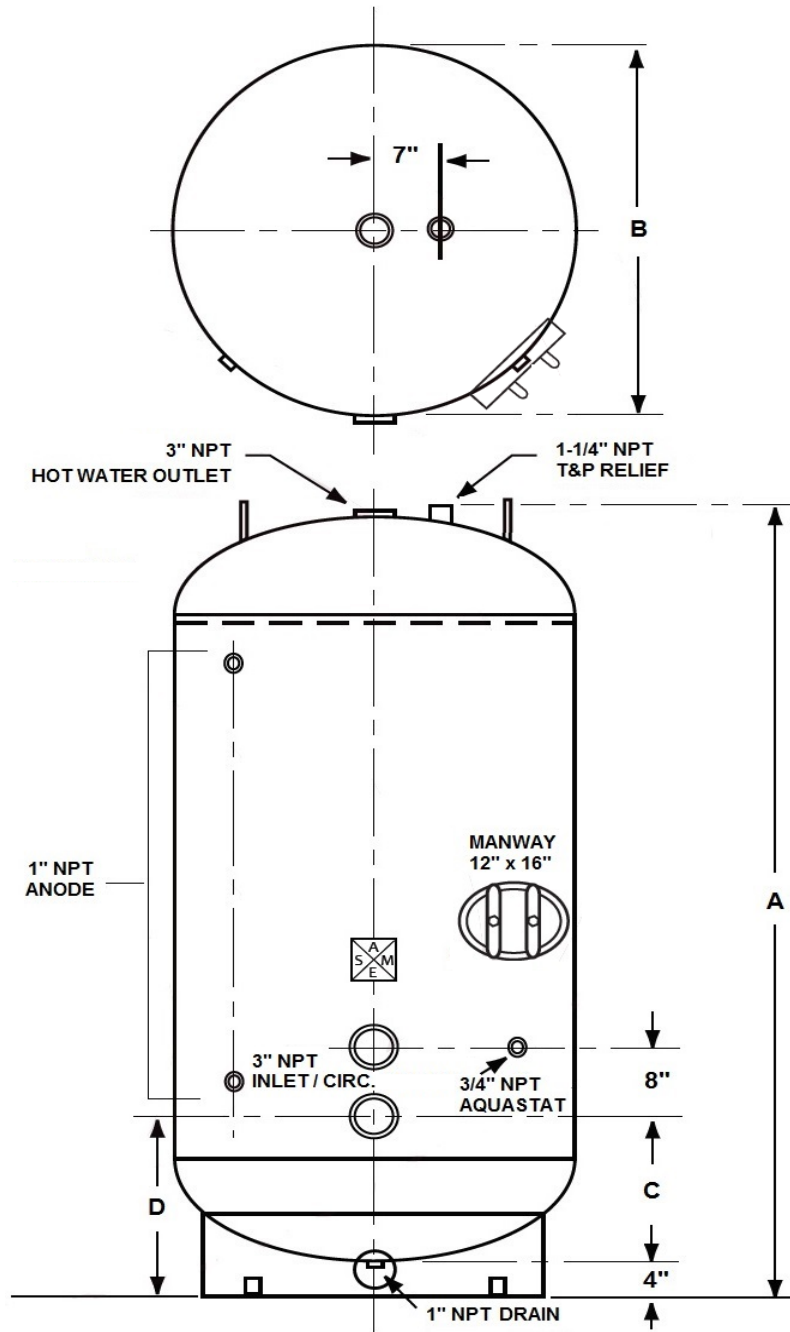

Large Volume Hot Water Storage Tanks

Tank Model TSV435-B*



TECHNICAL DATA

CAPACITY:	435 Gallon
CONFIGURATION:	Vertical
INTERIOR (LINING):	*Glass or Epoxy
EXTERIOR:	Red Oxide Primer
DESIGN PRESSURE:	125 psi
DESIGN BUILD:	ASME Section IV HLW Carbon Steel
WEIGHT:	785 lbs

* 1 = 10 Mils Glass Thickness; 2 = 20 Mils Glass Thickness; E = Epoxy

DIMENSIONS

ID	DESCRIPITON	DIMENSION
A	Height, Overall	85"
B	Diameter	42"
C	Circ., Bottom Conn. To Tank Bottom	16-1/2"
D	Circulation, Bottom Conn. To Floor	20-1/2"

SUBMITTAL

JOB NAME:	
LOCATION:	
ENGINEER:	
WHOLESALE:	
CONTRACTOR:	
DATE:	

Notes:

- 1) Tank information is subject to change without notice.
- 2) Tank options are available; Consult Factory.