

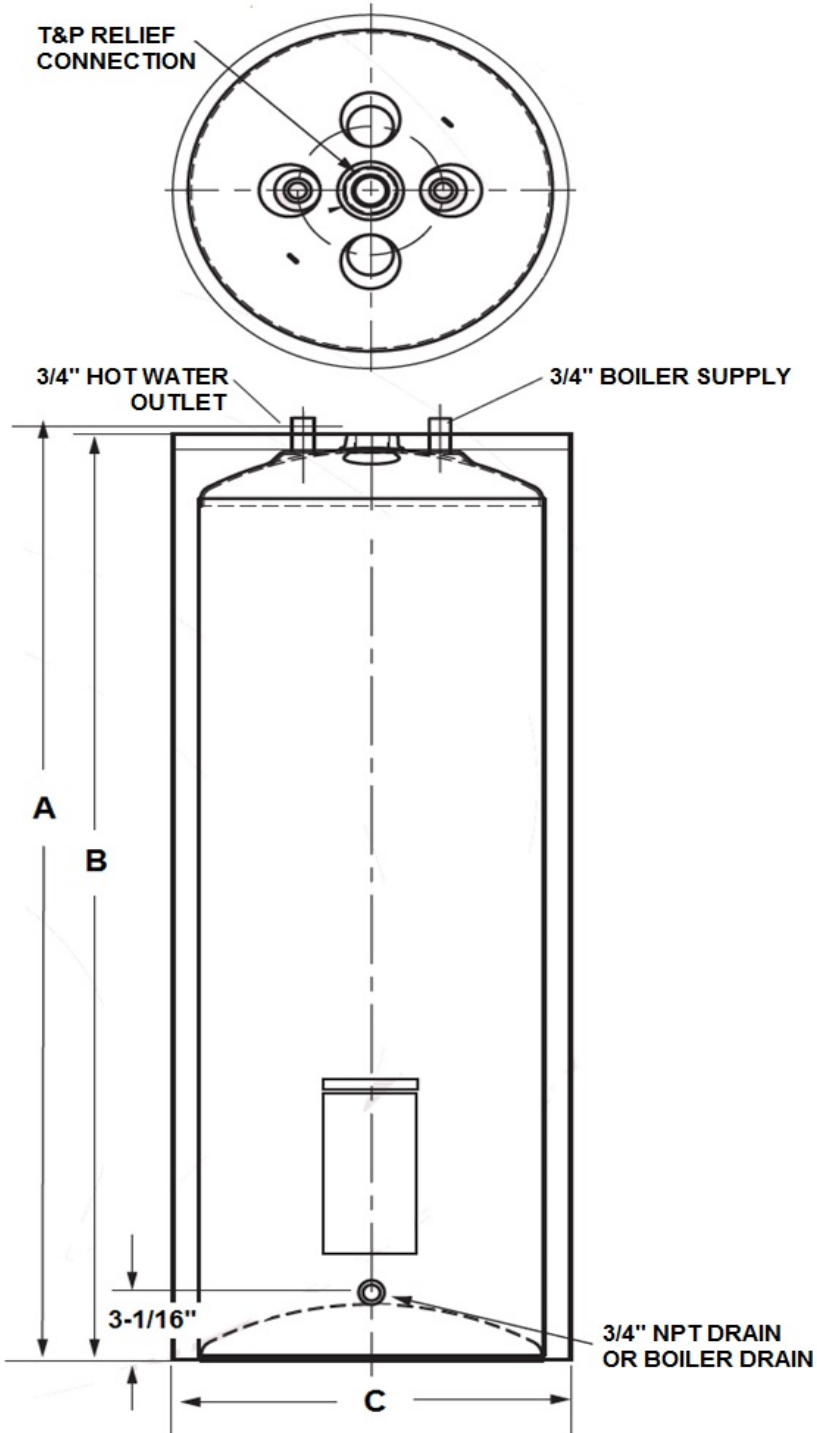

Small Volume Hot Water Storage Tanks Tank Model TSV40-J1



TECHNICAL DATA	
CAPACITY:	40 Gallon
CONFIGURATION:	Vertical
INTERIOR (LINING):	10 Mils Glass Thickness
EXTERIOR:	Steel Jacket with 2" Insulation
DESIGN PRESSURE:	150 psi
DESIGN BUILD:	Non-ASME Carbon Steel
WEIGHT:	103 lbs

DIMENSIONS		
ID	DESCRIPITON	DIMENSION
A	Height, Overall	47-7/8"
B	Height, Top of Jacket	46-5/16"
C	Diameter	22"
---	Drain, Conn. to Floor	3-1/16"

SUBMITTAL	
JOB NAME:	-----
LOCATION:	-----
ENGINEER:	-----
WHOLESALER:	-----
CONTRACTOR:	-----
DATE:	-----

- Notes:
- 1) Tank information is subject to change without notice.
 - 2) Tank options not available.