

## Large Volume Hot Water Storage Tanks

### Tank Model TSV340-B\*

TECHNICAL DATA	
<b>CAPACITY:</b>	340 Gallon
<b>CONFIGURATION:</b>	Vertical
<b>INTERIOR (LINING):</b>	*Glass or Epoxy
<b>EXTERIOR:</b>	Red Oxide Primer
<b>DESIGN PRESSURE:</b>	125 psi
<b>DESIGN BUILD:</b>	ASME Section IV HLW Carbon Steel
<b>WEIGHT:</b>	635 lbs

\* 1 = 10 Mils Glass Thickness; 2 = 20 Mils Glass Thickness; E = Epoxy

DIMENSIONS		
ID	DESCRIPITON	DIMENSION
A	Height, Overall	89"
B	Diameter	36"
C	Circ., Bottom Conn. To Tank Bottom	15"
D	Circulation, Bottom Conn. To Floor	19"

SUBMITTAL	
<b>JOB NAME:</b>	-----
<b>LOCATION:</b>	-----
<b>ENGINEER:</b>	-----
<b>WHOLESALE:</b>	-----
<b>CONTRACTOR:</b>	-----
<b>DATE:</b>	-----

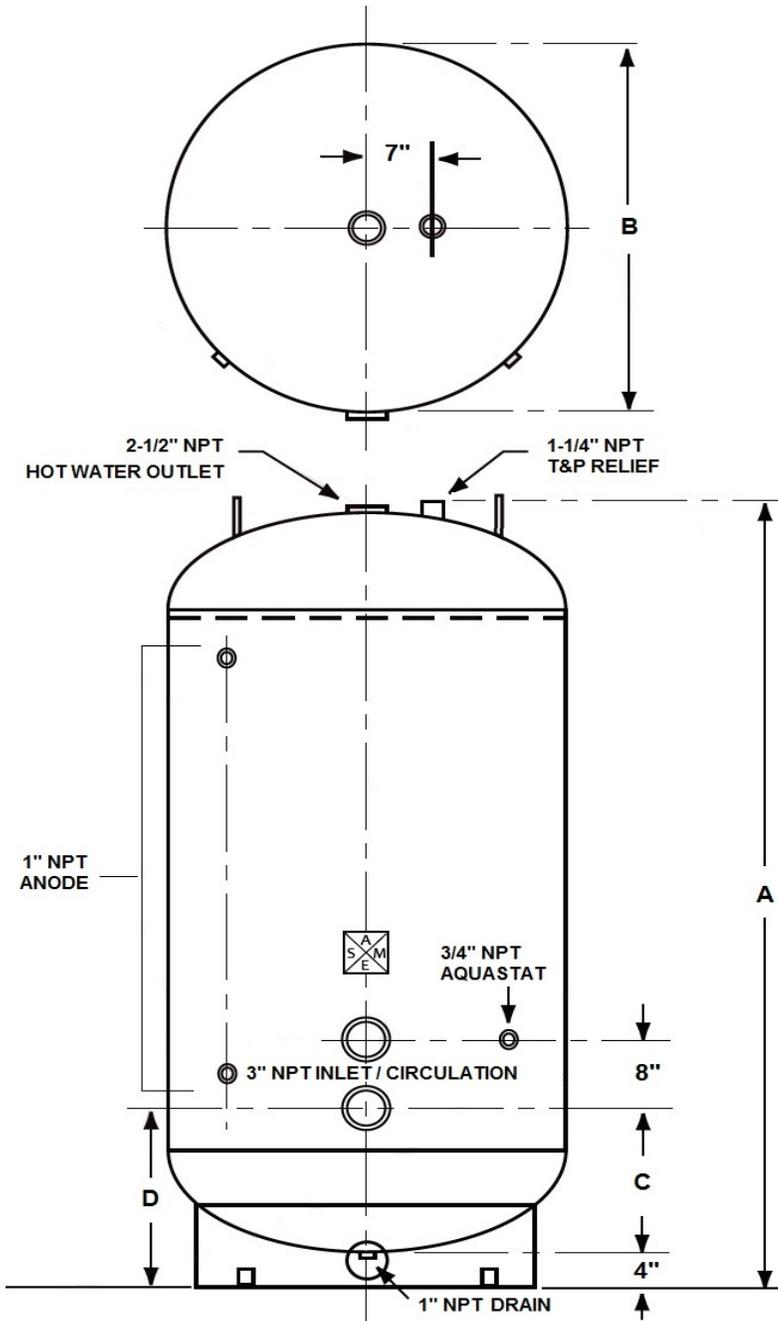

**Notes:**

- 1) Tank information is subject to change without notice.
- 2) Tank options are available; Consult Factory.