

Concert™ Control



Instruction and Operation Manual



Form 105975-01; Revision 11
April 18th, 2023

Contents

Introduction

Quick Reference	2
Overview	3

Product Features

Sequence	5
Protection Features	7
Single Unit Control	10
Multiple Unit Control Sequencer	11

Front Panel

General Navigation	14
Status Screens	15

Installation

Quick Setup	17
Terminal Layout	18
Unit-To-Unit Network	21
Energy Management Interface	23

Setup & Tuning

Manual Operation	31
Parameter Adjustment	32
Response Tuning	45

Trouble Shooting

General Issues	49
Sensor Status	52
Limit String Status	53
Soft Lockouts (Holds)	54
Hard Lockouts	56
Using Archives	59

Specifications

General	64
Parameter Summary	66

Application

The Concert™ Control (Control) has been designed for commercial hot water boiler and water heater applications.

Intent

This instruction manual includes detailed functional, installation and setup information. The intended users are application engineers, I&O manual and brochure writers, development and specifying engineers and installing contractors.



Figure 1: Control Front Panel
(Showing Home Screen)



Figure 2: Control

Introduction

Quick Reference

Application	Single Unit	Multiple Units	Energy Management System (EMS)			Manual Operation
			Unit Control		Modulation Rate Input	
			Single Unit Setpoint Input	Multiple Units Setpoint Input		
Setpoint						
Temperature Sensor	Supply	Header	Supply	Header	Ignored	Ignored
Setpoint	Operator	Operator	Input J8 (6-7) or Modbus*	Input J8 (6-7) or Modbus*	Ignored	Ignored
“On” and “Off” Point	Operator	Operator	Operator	Operator	Ignored	Ignored
Outdoor Air Reset	Option	Option	Ignored	Ignored	Ignored	Ignored
Domestic Hot Water Priority (DHWP)	Option	Option	Ignored	Ignored	Ignored	Ignored
Warm Weather Shutdown (WWSD)	Option	Option	Option	Option	Option	Ignored
Call For Heat						
Call For Heat	Based on Setpoints	Based on Setpoints	Based on Setpoints	Based on Setpoints	Input (RO) or Modbus	Based on Setpoints
Modulation Rate						
Firing Rate Demand	Internal	From Sequence Master	Internal	From Sequence Master	Input 4-20mA dc or Modbus*	Ignored
Remote Connection						
External Enable/Disable	Enable/Disable	Enable/Disable	Enable/Disable	Enable/Disable	On/Off	Ignored
Remote Control Input J8 (6-7) or Modbus*	No	No	Remote Setpoint	Remote Setpoint	Remote Modulation	Ignored
Additional Information	Page 9	Page 10	Page 20	Page 20	Page 20	Page 28

Table 1: Quick Reference

* Both Peer-To-Peer Network and Modbus Remote Control may be used at the same time.

Introduction

Overview

Control

The Concert Control (Control) contains features and capabilities which help improve heating system operation, and efficiency. By including unique capabilities, the Control can do more, with less field wiring, and fewer aftermarket controls and components – improving the operation of both new and replacement unit installations.

Advanced Touch Screen Display

Unit status and setup selections are available from an easy to use, full color, Touch Screen Display. In the event of a fault condition the user is guided by blinking touch buttons to help screens that explain the problem, cause, and corrective action. Operation evaluation and problem-solving is enhanced by historical capability including graphic trends, lockout history records, as well as burner and circulator cycle counts and run time hours.

Archives

Evaluation, optimization, and troubleshooting are enhanced by the collection of an operational record. Operation history is provided by major variable historical trending, time and day stamped alarms, lockout history, cycles, run hours, and unit loading profiles. These tools may be used on site or downloaded to a thumb drive for review off site.

Advanced Modulating Control

The Control modulates the unit input by varying the fan speed. As the fan speed increases, so does the amount of fuel gas drawn into the blower. As a result, a fairly constant air-fuel ratio is maintained across all inputs. The Control determines the input needed by looking at both current and recent differences between the measured temperature and the setpoint temperature. As the measured temperature approaches the setpoint temperature, the fan will slow down and the input will drop. The Control also utilizes unit return water and flue gas temperatures to adjust fan speed.

Built-in Safety Control

The Control includes safety controls designed to ensure safe and reliable operation. In addition to

flame safety controls the Control includes supply water temperature, differential water temperature, and stack temperature safety limits, as well as stepped modulation responses. Unit modulation is adjusted when required to help avoid loss of operation due to exceeding limits. Additionally, the Control monitors the safety limits and displays cause of unit alarm trip and start delay.

Outdoor Air Reset

When selected the active setpoint is automatically adjusted based on outside air temperature, time of day, and length of demand (boost) settings. Outdoor air “reset” setpoint saves fuel by adjusting the water temperature of a heating boiler lower as the outside air temperature increases.

Auxiliary Equipment Control

The Control may be used to sequence the domestic hot water, unit and system circulators, or fresh air damper. Circulators are automatically run for a 20 second exercise period after not being used for longer than 7 days. Circulator exercise helps prevent pump motor shaft seizing.

Energy Management System (EMS) Interface

The control accepts a 4-20mA dc input from the EMS system for either direct modulation rate or setpoint. A factory configured RS485 Modbus interface is available for Energy Management System (EMS) monitoring or control. Additionally the Multiple Unit Sequencer Peer-To-Peer Network may be used at the same time the EMS is monitoring and providing setpoint over the Modbus network.

Multiple Unit Peer-To-Peer Network

The Control includes state-of-the-art modulating lead-lag sequencer for up to eight (8) units, capable of auto rotation, outdoor reset, and peer-to-peer communication. The peer-to-peer network is truly “plug and play”. Communication is activated by simply connecting a RJ45 Ethernet cable between units. The Control provides precise unit coordination by sequencing units based on both header water temperature and unit modulation rate. For example, the lead unit can be configured to start a lag unit after operating at 50% modulation rate for longer than an adjustable time. The units are modulated in “unison” (parallel) modulation rate to ensure even heat distribution.

Introduction
Overview

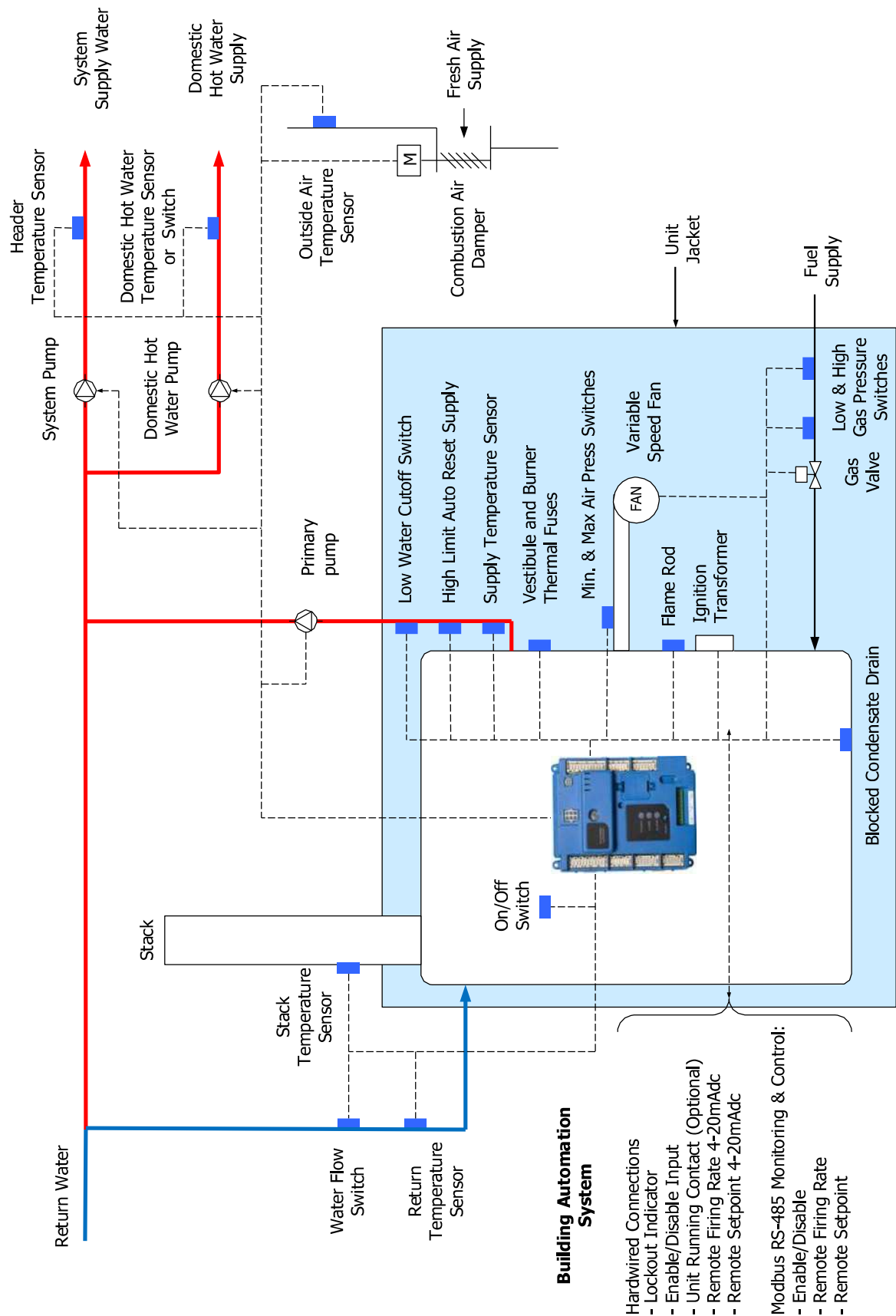

Figure 3: Unit Control

Product Features

Sequence

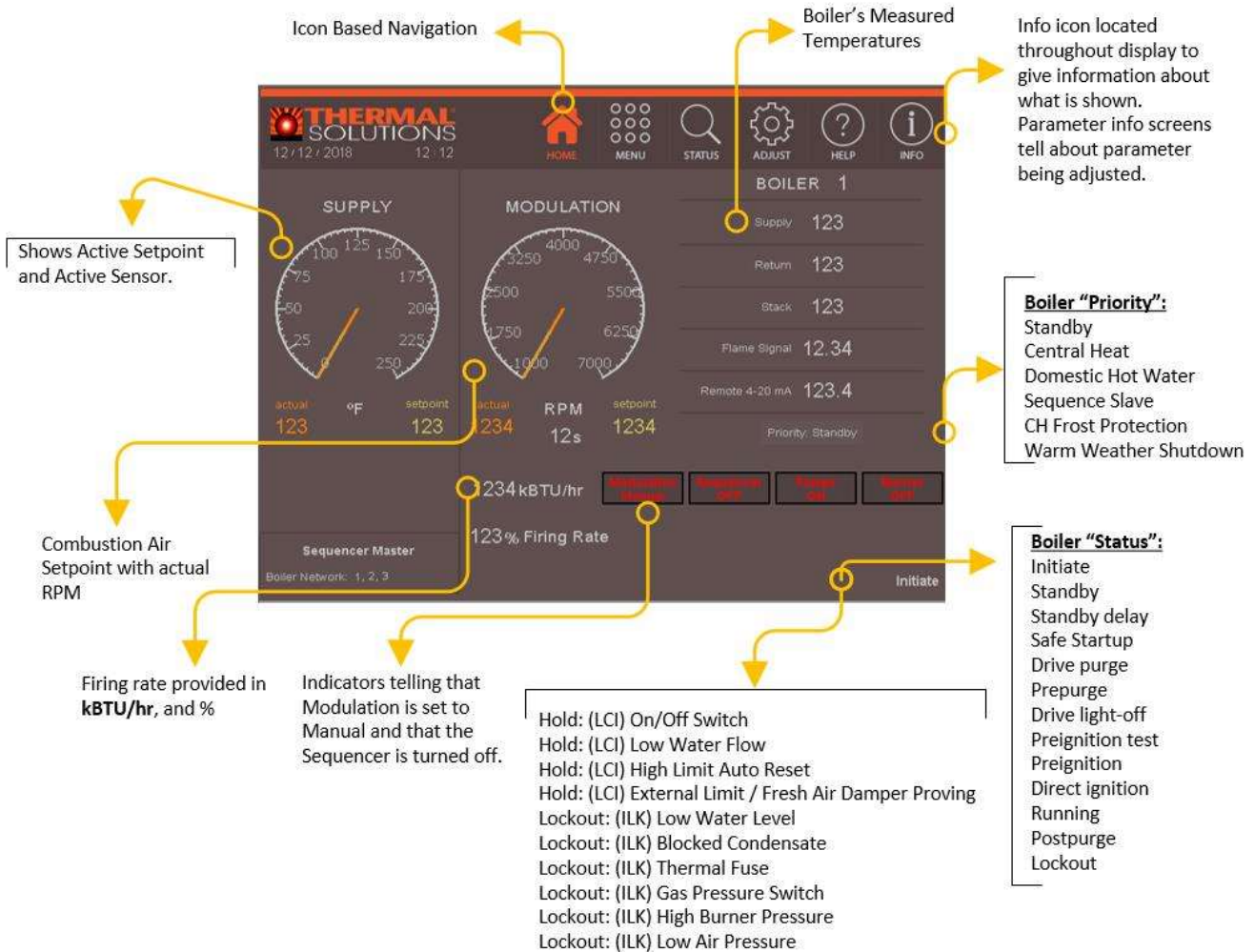

Figure 4: Home Screen Details

"Priority"

The Control accepts a call for heat (demand) from multiple places and responds according to the "Priority." When more than 1 demand is present the higher priority demand is used to determine active unit settings. For example, when Domestic Hot Water (DHW) has priority the setpoint, "Diff Above", "Diff Below" and pump settings are taken from DHW selections. Active "Priority" is displayed on the "Home" screen above. Priority Order is shown in Table 2.

Table 2: Order of Priority

Priority	Display	Unit Responding to:
1st	Sequencer Control	The unit is connected to the peer- to-peer network. The unit accepts demand from the Sequencer Master.
2nd	Domestic Hot Water	DHW call for heat is on and selected as the priority demand. DHW is always higher priority than Central Heat. It also has higher priority than the Sequencer Control when DHW priority is "enabled" and "Boiler Piped" IWH is selected.
3rd	Central Heat	Central Heat call for heat is on and there is no DHW demand or DHW priority time has expired.
4th	Frost Protection	Frost Protection is active and there is no other call for heat. Frost protection will be a higher priority than Sequencer Control if the Sequence Master has no active call for heat.
5th	Warm Weather Shutdown (WWSD)	WWSD is active and the unit will not respond to central heat demands. DHW demand is not blocked by WWSD.

Product Features

Sequence

Sequence Status is shown on both the Home screen and the Status Screen. Once limits have been established the start/stop sequence progresses as show in the graph below;

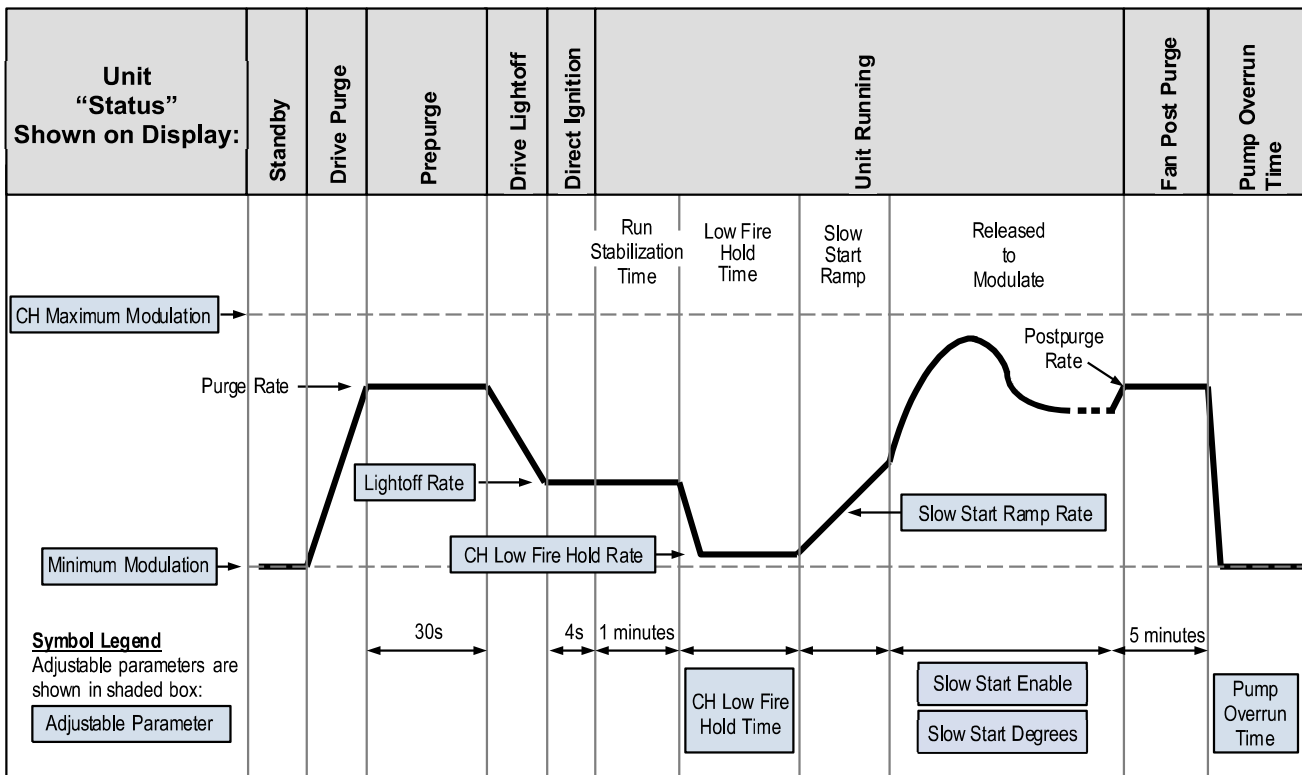

(Note: refer to Parameter Adjustment for additional information.)

Figure 5: Central Heat Start sequence (Typical for Domestic Hot Water)

Table 3: Sequence

Status:	Description
Standby	Unit is not firing. Appropriate circulators are "On" if "Priority" is not standby. There is a Central Heat call for heat and the Supply temperature is greater than setpoint minus the "Diff Below".
Prepurge	When supply temperature drops below setpoint minus the "Diff Below," burner demand continues with following Status shown: Safe Startup: Flame circuit is tested. Drive purge: The blower is driven to the fan purge speed. Prepurge: After the blower reaches the fan purge speed setting the 30 second combustion chamber purge is conducted.
Direct Ignition	After purge time is complete the following Status is shown: Drive light-off: The blower is driven to light-off rate. Pre-ignition Test: After the blower reaches light-off rate a safety relay test is conducted. Pre-ignition: Spark is energized and it is confirmed that no flame is present. Direct Ignition: Spark and Main fuel valve are energized.
Running	After the flame is proven the sequence continues with run stabilization and, when selected, low fire hold time and slow start ramp. Once the field adjustable low fire hold time and ramp rate is completed normal operation begins, modulation rate depending on temperature and setpoint selections.
Post-purge	When the call for heat ends the main fuel valve is closed and the blower is driven to the fan post-purge speed. After the blower reaches the fan post-purge speed setting the 5 minute second combustion chamber purge is conducted.

Product Features

Unit Protection Features

Supply Water Temperature High Limit

The Control is equipped with internal operating control and high limit features. The Control monitors a dual element temperature sensor that is mounted in the supply water manifold and provides UL353 and UL1998 internal safety algorithms. If supply water temperature increases above the active setpoint plus diff above, default 180°F (82°C) (maximum setting 190°F (88°C)) the unit is cycled off. If the temperature exceeds 200°F (99°C), a manual reset hard lockout results. Additionally, the supply temperature is monitored by a L4008A High Limit Aquastat set to recycle the unit at 195°F with a 5°F differential.

Stepped Modulation

While the unit is a slave responding to the internal Multiple Unit Control Peer-Peer Network, an Energy Management System (EMS) demand, or has Header sensor selected as Central Heat Modulation Sensor the Control still monitors supply water temperature to prevent unit over firing. The unit's maximum modulation is reduced from 100 to 0% if the supply water temperature increases from 190°F (88°C) to 200°F (93°C). If supply water temperature exceeds 200°F (93°C) a forced recycle results.

Sequence Master Stop All Units

All units are stopped without delay if the Call for Heat input is removed or if the header temperature is higher than 195°F (90.6°C) (field adjustable).

High Differential Temperature Limit

The Control monitors the temperature difference between the return and supply sensors. If this difference exceeds 80°F (45°C) the control begins to reduce the maximum blower modulation. If temperature difference exceeds 90°F (50°C) a forced unit recycle results. If the temperature difference exceeds 100°F (56°C) the control will shut the unit down. The unit will restart automatically once the temperature difference has decreased and the minimum off time has expired. If the differential temperature exceeds the 100°F limit ten times the manual reset Hard Lockout is set. Additionally, if the supply temperature rises faster than the 4°F (2°C) per second limit, a soft lockout is activated.

Return Higher Than Supply Temperature

The Control monitors the supply and return temperature sensors. If the return water temperature exceeds the supply water

temperature for longer than a limit time delay, the Control shuts down the unit and delays restart. If the inverted temperature is detected more than five times the manual reset Hard Lockout is set. This condition is the result of incorrectly attaching the supply and return piping.

Stack High Limit

The Control monitors a dual element temperature sensor that is mounted in the vent connector and provides UL353 and UL1998 internal safety algorithms. If the flue temperature exceeds 210°F (99°C), the control begins to reduce the maximum blower modulation. If the flue temperature exceeds 220°F (104°C), a forced recycle results. If the flue temperature exceeds 230°F (110°C), the manual reset Hard Lockout is set.

Ignition Failure

The Control uses an external igniter. The Control monitors ignition using a burner mounted flame sensor. In the event of an ignition failure, the control will recycle. If ignition fails after a single retry, a manual reset Hard Lockout is set.

Central Heating System Frost Protection

When enabled, Frost Protection starts the unit and system pump and fires the burner when low outside air and low supply water temperatures are sensed. Outdoor Air setpoint is field adjustable. The Control provides the following control action when frost protection is enabled:

Device	Start Temperatures	Stop Temperatures
Primary pump	Outlet Water < 45°F	Outlet Water > 50°F
System Pump	Outside Air < 32°F Supply Water < 45°F	Outside Air > 36°F Supply Water > 50°F
Burner	Outlet Water < 38°F	Outlet Water > 50°F

Table 4: Frost Protection

FROST PROTECTION NOTE

The Control helps provide freeze protection for the unit's water. The Outside Air sensor is used for starting only the system pump, not the primary pump. Flue gas condensate drain is not protected from freezing. Since the Control may only cycle the system and unit circulators individual zones are not protected. It is recommended that the unit be installed in a location that is not exposed to freezing temperatures.

Product Features

Sequence

Unit “Status” Shown on Display:		Temp >Setpoint					CH Enabled & Temp < Setpoint (lead unit demand active)												
		Standby CH Disabled	Standby DHW Disabled	Standby DHW Enabled	Standby CH Enabled	Frost Protection On	Lockout	LCI Open	Warm Weather Shutdown	Standby	Limit Hold	Drive Purge	Prepurge	Drive Lightoff	Direct Ignition	Boiler Running	Pump Overrun Time	Fan Post Purge	
Inputs	ILK OFF																		
	LCI OFF																		
	Warm Weather Shutdown																		
	Frost Protection On																		
	CH Enabled																		
	DHW Enabled																		
Relay Outputs	Blower Output																		
	Alarm Relay																		
	System Pump																		
	DHW Pump																		
	Isolation Valve			Lea d Boiler Only															
	Unit Pump																		

Notes

- System Pump:Runs when boiler room has heat demand enabled. Is shut off when unit is in Warm Weather Shutdown (WWSD).
- DHW Pump:Runs when there is a domestic demand.
- Isolation Valve:Opens if unit is a lead and when the unit has burner demand. Closes when the unit is locked out or in WWWSD.
- Primary pump:Runs when unit has burner demand. Stops when the unit is locked out or in WWSD.

Product Features

Protection Features

Limit Devices

The control monitors individual limit devices as shown in Figure 6 below. If any of these limits open the unit will shut down and an open limit indication is provided. Additionally, the control monitors an air proving switch.



Limit Type	Limit String	Description	Status
STAT	STAT	External Enable/Disable	ON
STAT	S6	Domestic Hot Water Demand	OFF
LCI	A1	(LCI) On/Off Switch	ON
LCI	A2	(LCI) Low Water Flow	ON
LCI	A3	(LCI) High Limit Auto Reset	ON
LCI	LCI	External Limit/Fresh Air Damper Proving	ON
ILK	A4	(ILK) Low Water Level	ON
ILK	A5	(ILK) Blocked Condensate	ON
ILK	A6	(ILK) Thermal Fuse	ON
ILK	A7	(ILK) Gas Pressure Switch	ON
ILK	A8	(ILK) High Burner Pressure	ON
ILK	ILK	Low Air Pressure	ON

Note

During the start sequence the control requires the Air Proving Switch, “API” to be “OFF” before the blower starts and in the “ON” position after the blower starts. If the API is not in the required position the start sequence is halted or the unit is shut down and the “Low Air Pressure” OFF limit indication is provided.

Figure 6: Limit Monitoring Screen Showing Central Heat Demand

Table 5: Limit String

Limit String Type	Description	Action
STAT	Heat Demand	<p>After a Heat demand is received, “ON” the control is enabled to fire to maintain water temperature at setpoint.</p> <ul style="list-style-type: none">Heat demand may be received from “STAT” terminal for Central Heat demand, “S6” terminal for Domestic Hot Water demand, the Sequence Master, or EMS Modbus Inputs.A Heat Demand input ON initiates pumps and Fresh Air Damper outputs.
LCI	Load Control Input	<p>The unit will not start if the LCI is OFF. When it is turned OFF during run, the unit shuts down.</p> <ul style="list-style-type: none">Hold message is shown when LCI limit is OFF and Heat Demand ON.LCI Hold will never cause a manual reset lockout.Unit may be disabled remotely by wiring an enable contact to the LCI “External Limit” terminals.When the Low Air Pressure Switch (APS) is proven OFF the LCI input turns ON and initiates blower start. When Low APS fails to turn ON, the control enters a manual reset Lockout state.
ILK	Interlock	<p>The unit will not start if the ILK is OFF. When it is turned OFF during run, the unit enters a manual reset Lockout state.</p> <ul style="list-style-type: none">The ILK must be ON within 1 minute after the LCI is ON. This time allows the blower to start and the air flow proving switch to turn ON. Failure to close will cause a manual reset lockoutILK OFF Lockout cause the Lockout Alarm contact to turn ON.

Product Features

Single Unit Control

Control Options

- Modulating Sensors
 1. Supply
 2. Header
 3. Domestic Hot Water
- Modulation Setpoint
 - Outdoor Air Reset
 - Warm Weather Shutdown
 - Frost Protection
 - EMS interface
- Device Control
 - Unit, System & Domestic pumps
 - Fresh Air Damper

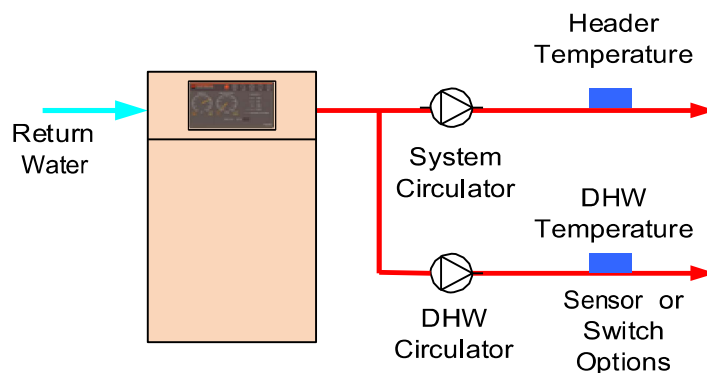

Figure 7: Single Unit Hydronic Options

Modulation Setpoint

The Control starts and stops the unit and modulates the unit input from minimum (MBH) to maximum (MBH) in order to heat water to the active setpoint. The setpoint is determined by the priority (Domestic Hot Water, Central Heat, Frost Protection and Warm Weather Shutdown) and as described in the following paragraphs

Central Heat

User may select the Supply sensor or Header Sensor as the Modulation Sensor. Upon a Central Heat call for heat the setpoint is either the user entered Central Heat Setpoint, or automatically adjusted by Outdoor Air Reset, Energy Management System (EMS), supplied 4-20mA_{dc}, or Modbus setpoint input.

Outdoor Air Reset

When selected the modulation rate setpoint is automatically adjusted based on outside air temperature, time of day input and demand duration (boost) settings. Outdoor air “reset” setpoint saves fuel by adjusting the active setpoint of a heating unit lower as the outside air temperature increases.

Domestic Hot Water (DHW) Setpoint

User May select the Supply sensor or DHW Sensor as Modulation Sensor. Upon a DHW call for heat the setpoint is either the user

entered DHW setpoint or the time of day input DHW setpoint. The optimal value of this setpoint is established based on the requirements of the indirect water heater.

Domestic Hot Water Priority (DHWP)

Some boilers are used primarily for building space heating, but also provide heat for the domestic hot water users. When the outdoor temperature is warm, the outdoor reset setpoint may drop lower than a desirable domestic hot water temperature. Also, often it is required to quickly recover the indirect water heater. When DHWP is enabled, heating circulators are stopped, the domestic circulator is started and the domestic hot water setpoint is established in response to a domestic hot water demand. Priority protection is provided to allow the heating loop to be serviced again in the event of an excessively long domestic hot water call for heat.

Device Control

The Control may be used to sequence the domestic hot water, unit and system circulators or fresh air damper.

Selecting This Control Mode

To select single unit control set the following:

Press Adjust Menu > Sequence Master;
Select Sequence Master = Disabled.

Press Main Menu > EMS Interface > Remote Demand;
Select Modulating Source = Local.

Product Features

Multiple Unit Control Sequencer

Control Options

- Modulating Sensors
 1. Header
- Modulation Setpoint
 - Outdoor Air Reset
 - Warm Weather Shutdown
 - Frost Protection
 - EMS interface
- Device Control
 - Unit, System & Domestic pumps
 - Fresh Air Damper

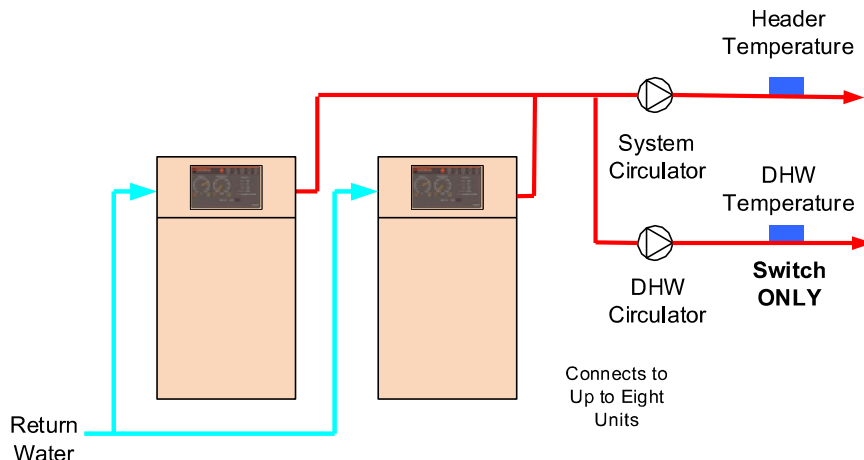

Figure 8: Multiple Unit Hydronic Options

Sequencer Master

A single Control is parameter selected to be the Sequencer Master. The Sequence Master does not rotate. The call for heat, outdoor and header sensors, and common pumps are wired to the Sequencer Master “enabled” Control.

Lead/Slave Sequencing

The Sequence Master is independent of the “Lead” unit. One unit is a “Lead” unit and the remaining networked units are “Slaves”. When demand is increasing, the Lead unit is the first to start and the Slave units are started in sequential order (1, 2, 3,...) until the demand is satisfied. When demand is decreasing, the units are stopped in reverse order with the Lead unit stopped last (... , 3, 2, 1). To equalize the run time the sequencer automatically rotates the Lead unit after 24 hours of run time.

Customized Sequences

Normally, units are started and stopped in numerical order. However, custom sequences may be established to optimize the heat delivery. For example, in order to minimize burner cycling, a large unit may be selected to run first during winter months and then selected to run last for the remainder of the year.

DHW Two boiler Start

When the Indirect Water Heater (IWH) parameter is set to “Primary Piped” and the DHW Two Boiler Start parameter is set to “Enabled” two boilers are started without delay in response to a DHW call for heat. This feature allows rapid recovery of large IWH’s and multiple IWH’s.

Concert Control Instruction & Operation Manual

Shared or Isolated DHW Demand

When the Indirect Water Heater (IWH) parameter is set to “Primary Piped” the Sequence Master sequences all required boilers to satisfy the DHW setpoint (default 180°F (82.2°C)). When “Boiler Piped” is selected only the individual slave boiler, with the wired DHW demand and pump, fires to satisfy the DHW setpoint.

Multiple Demands

The Sequence Master responds to Central Heat, DHW and frost protection demands similar to the stand alone unit. For example, when selected and DHW priority is active, the sequence master uses DHW setpoint, “Diff Above”, “Diff Below” and pump settings. However, the Sequence Master always uses the Header sensor and does not use the DHW Sensor.

Optimized Modulation

Firing rate is managed to increase smoothly as units are started. For example, when a second unit is started the initial firing rate is 100%/2 or 50%, when the third unit is started the firing rate starts at 200%/3 or 66%. After the initial start, the Sequence Master develops a unison firing rate demand based on its setpoint and header temperature.

Selecting This Control Mode

Under Adjust Menu, select Sequence Master and then select Sequence Master Enable.

Product Features

Multiple Unit Control Sequencer (continued)

During low loads, the Sequence Master limits firing rates to a “Base Load Rate” to ensure modulating condensing unit peak operating efficiency. Lower firing rates boost efficiency by helping increase the amount of flue gas water vapor condensation. The Control maintains a “Base Load Rate” until the last lag unit is started. At this point, the “Base Load Common Rate” is released to allow units to modulate as required to meet heat load.

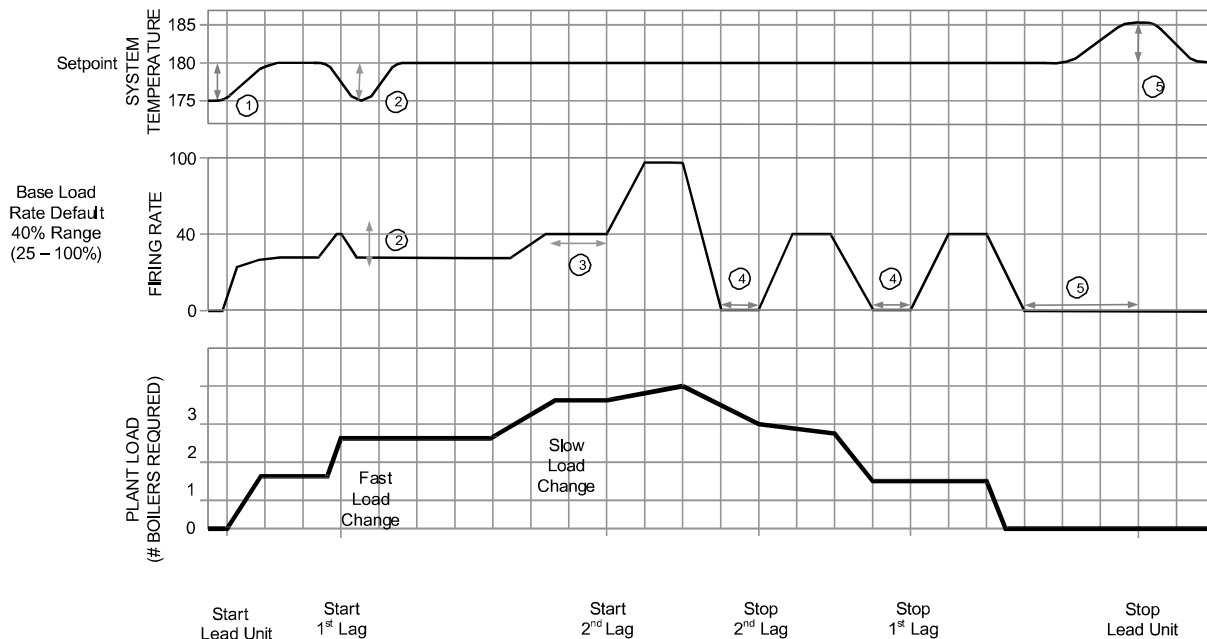

Figure 9: Unit Start and Stop Peer-To-Peer Network Sequence Diagram
(3 unit system shown, typical for up to 8 units)

Advanced Sequencing

After there is a Call for Heat input, both header water temperature and firing rate percent are used to start and stop the networked units. The control starts and stops units when the water temperature is outside the user selected “Difference Above” and “Difference Below” settings. Also, in order to minimize temperature deviations, the control adjusts the number of units running based on the firing rate. This combination allows the units to anticipate slow load changes before they disrupt water temperature, yet still respond quickly to sudden load changes. These special sequencer features help reduce energy wasting system temperature swings and the resulting unnecessary cycling.

- ① - **Lead Unit Start**
Water temperature is below the setpoint by more than the “On Point” differential.
- ② - **Temperature Based Lag Unit Start**
Water temperature is below the setpoint by more than the “Difference Below” parameter for longer than the adjustable time delay (“Unit Start Delay” parameter).
- ③ - **Modulation % Based Lag Unit Start**
The unit modulation rate has been at the maximum firing rate for longer than twenty minutes.
- ④ - **Lag Unit Stop**
The unit modulation rate has been at minimum fire for longer than twenty minutes. Additionally, lag units are stopped when water temperature is above the setpoint by more than the “Difference Above” parameter for longer than the “Unit Stop Delay” parameter.
- ⑤ - **Lead Unit Stop**
The last unit remains on line until the water temperature is above the setpoint more than the “Difference Above” for longer than the time delay.

Product Features

Multiple Unit Control Sequencer (continued)

Improved Availability - The following features help improve the heat availability:

Backup Header Sensor

In the event of a header sensor failure the lead unit's supply sensor is used by the Sequence Master to control firing rate. This feature allows continued coordinated sequencer control even after a header sensor failure.

Slave Unit Rate Adjustment

Each slave unit continues to monitor supply, return and flue gas temperatures and modifies the Sequence Master's firing rate demand to help avoid individual unit faults, minimize unit cycling and provide heat to the building efficiently.

Slave Unit Status Monitoring

The Sequence Master monitors slave unit lockout status and automatically skips over disabled units when starting a new slave unit.

“Stand Alone” Operation Upon Master Failure

Individual units are configured to continue to operate in the event the Sequence Master Control is powered down, disabled or Unit-to-unit communication is lost. The following are design considerations for backup “Stand Alone” operation;

- **Enable/Disable**
Upon loss of the Sequence Master each unit will automatically begin local control. This means it will operate only if it has a call for heat. For this reason slave units should have their “External Enable/Disable” J8 terminal 1 to 3 jumpered. In the event of loss of Sequence Master the slave unit will have demand to run.
- **Modulation**
Once running the Slave unit will use the selected central heat modulation sensor and setpoint to produce heat for the building. Optionally, slave units may have a separate header sensor wired and select the “Central Heat Modulation Sensor” parameter as Header Sensor”. This will allow continued header water temperature control.
- **Pumping**
Consideration must be given to how the system pump is powered. If the Sequence Master enabled unit is powered down, how will the system pump be operated? It may be required to wire the system pump to multiple units.

Once the Sequence Master is restored to operation the individual units automatically resume their position as sequencer slaves.

Front Panel

General Navigation

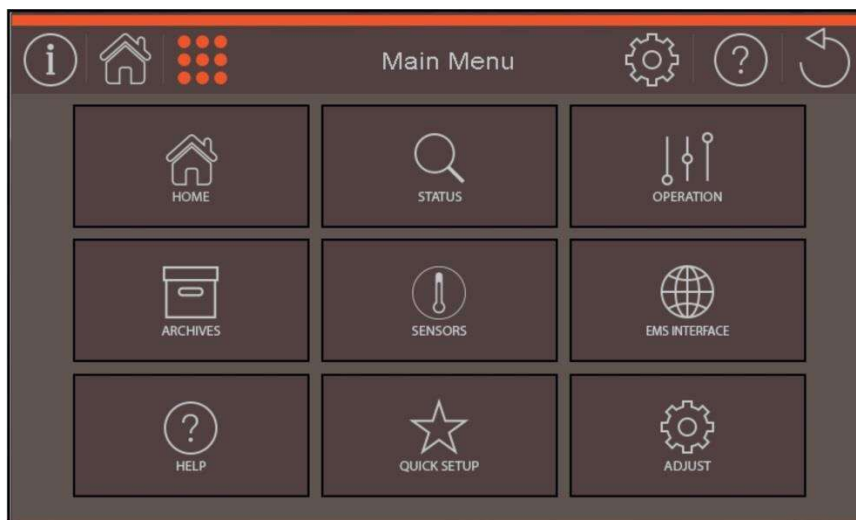

Figure 10: Main Menu

Main Menu

The Main Menu provides access to all display functions. It is accessible from the Home Screen. The following major user interface areas are accessed from the Main Menu:

STATUS

Provide a “walk” through unit operation. These screens provide an overview of unit and networked unit operation. The status screens include “Load Profile” for Central Heat and Domestic Demands. These profiles allow the user to review the Run Hour (%) versus Load (%). The “Load Profile” along with run hours and cycles provides a complete picture of unit status.

OPERATION

The operation screens allow the user to take manual or automatic control of the unit. These screens are intended to allow a technician to set firing rate to support combustion testing and provide trending and parameter adjusting to support fine tuning the unit’s response to load changes. Operation screens may be used to speed up or slow down the unit’s response to fast or slow system load changes.

ARCHIVES

The Archives collect the history of how the unit has operated and provides tools to review and improve system operation;

- A historical trend – Up to four (4) months of data is collected and may be viewed on screen or saved to a Thumb Drive.

- Lockout History – provides data on up to 15 manual reset Lockouts. Data collected includes cause of unit trip, run hour and status when lockout occurred.
- Cycle & Run Time History – collects the usual summary of cycles and hours of unit and pump operation. All cycles and run hours other than the controller quantities may be reset to aid in identifying improvements made.
- Alarm History – limit string faults, holds, lockouts and other alarms are recorded with time and date stamp.
- Thumb Drive Operation – these screens provide ability to save or load parameters as well as alarm and trend data.

SENSORS

Status and details are provided on all sensors connected to the Control.

EMS INTERFACE

EMS setup options and status is provided.

HELP

Active alarms and corrective actions are provided.

QUICK SETUP

Commonly required parameters are presented for quick review and adjustment.

ADJUST

Each adjustable parameter is presented for adjustment. Proper login is required.

Front Panel

Status Screens

Unit Status screens are the primary monitoring screens. The user may simply “walk” through unit operation by repeatedly selecting the right or left “arrow” symbol. These screens are accessed by selecting the “status” button from the “Home” or “Menu” screens.

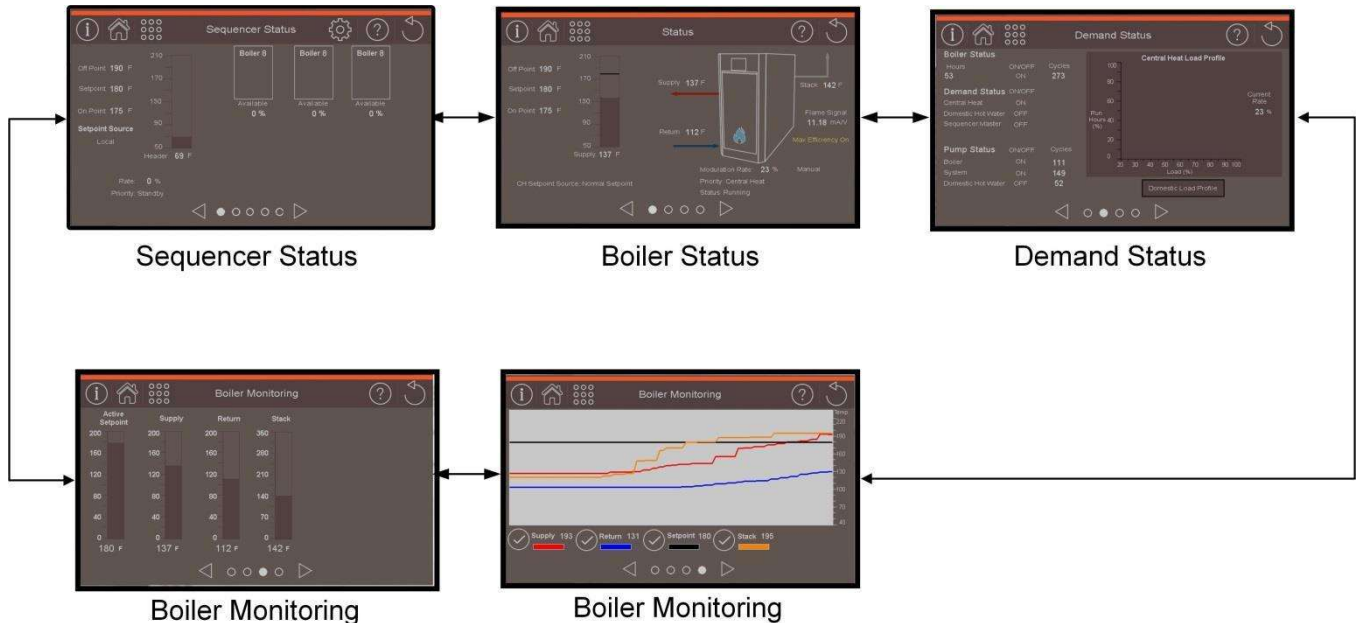

Figure 11: Status Screen Navigation

Sequencer Status

This screen only appears when the Sequencer Master is enabled. It shows data involved with the network including active setpoint and sensor, the network priority, and the setpoint source.

This status screen also displays all units in the unit-to-unit network. For each unit, the status screen will tell it's assigned unit number, current state, firing rate, and whether it is the current Lead unit.

Unit Status

This screen gives an overview of the current status of the unit. The active setpoint and sensor which the unit is currently modulating based on are displayed using a bar graph & numeric values.

Also displayed are all current sensors installed in the unit. These sensors will display red if there is an issue with any of them.

Additional information shown on this page includes current firing rate, priority, current status, and setpoint source.

Demand Status

This page gives the demand status of the Central Heat, Domestic Hot Water, and Sequencer (Lead Lag). Along with this status, the unit run hours, on/off status, and cycles are also shown.

Pump information is also included on this page including on/off status and cycles. Frost Protection status and Exercise will also appear when used.

Additionally, the Load Profiles are on this page, which give historic data on the modulation of the unit. This graph shows the percentage of the total run hours the unit spends modulating at each rate (%).

Unit Monitoring

This is an overview of all sensors installed on the unit represented as bar graphs. Numeric values are also provided for accurate readings.

Front Panel

Status Screens

The status screen shows data relevant to current unit operation. All installed sensors are shown on this page as well as current modulation %, setpoint, active sensor, and much more. A detailed screen map is shown below.

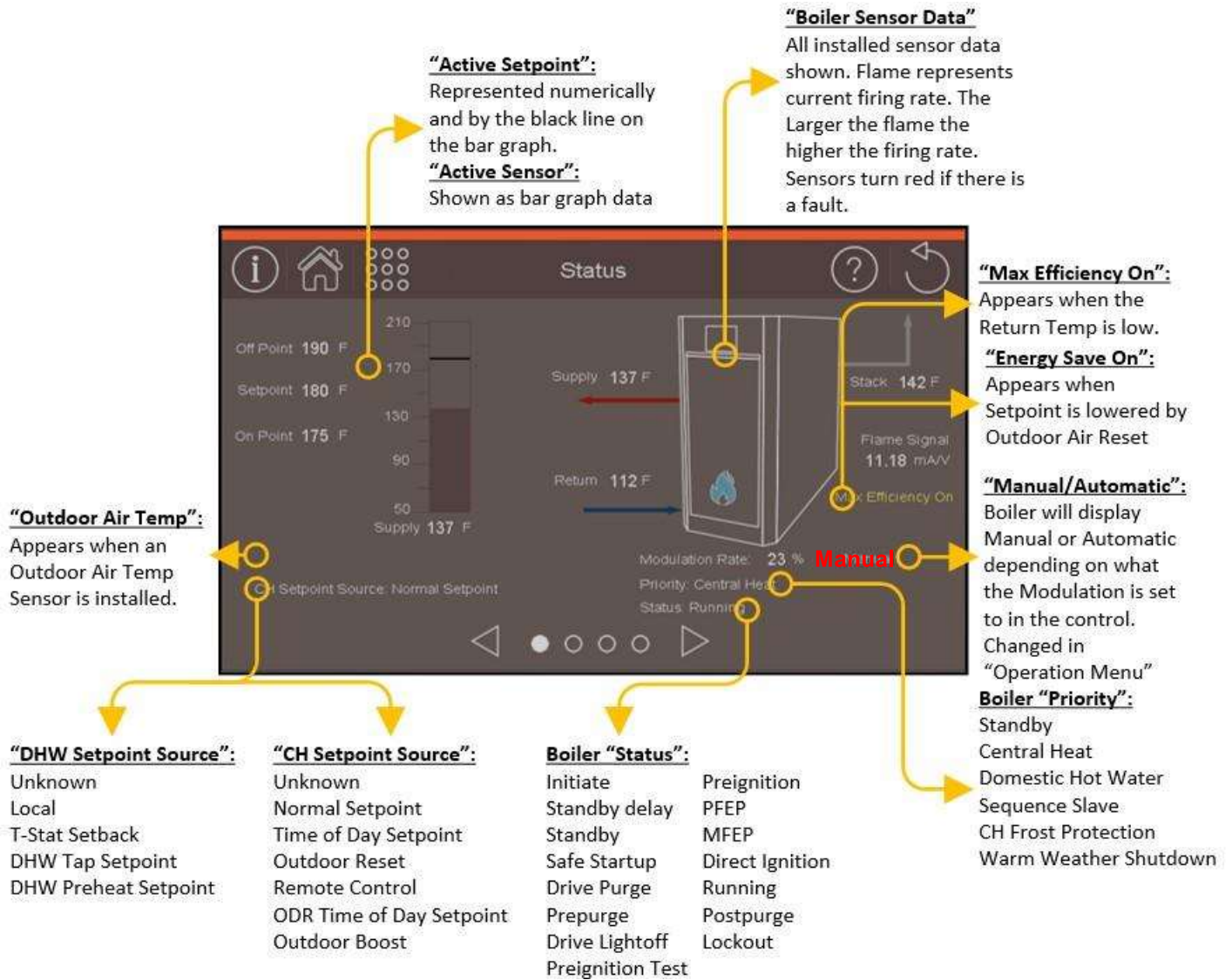

Figure 12: Status Screen Detail

Installation

Quick Setup

The Quick Setup Menu is accessed from the Main Menu Screen. The Quick Setup menu allows the user to review and adjust the most commonly adjusted parameters, such as Setpoints and pump output settings, from one location. Refer to Parameter Adjustment section for additional information.

Setpoints

Factory Setting	Range / Choices	Parameter and Description
180	50 to 190 (°F)	Central Heat Setpoint
10	3 to 29 (°F)	Central Difference Above
5	3 to 29 (°F)	Central Difference Below
180	50 to 190 (°F)	Domestic Hot Water Setpoint
10	3 to 29 (°F)	Domestic Difference Above
5	3 to 29 (°F)	Domestic Difference Below
32	-50 to 50 (°F)	CH Frost Protection Setpoint
70	20 to 100 (°F)	Warm Weather Shutdown Setpoint
195	50 to 195 (°F)	Stop All Units

Comfort

Factory Setting	Range / Choices	Parameter and Description
30 (°F)	-50 to 32 (°F)	Minimum <u>Outdoor</u> Temperature
70 (°F)	35 to 100 (°F)	Maximum <u>Outdoor</u> Temperature
110 (°F)	70 to 180 (°F)	Low <u>Water</u> Temperature
130 (°F)	50 to 185 (°F)	Minimum Boiler Water Temperature

Response

Factory Setting	Range / Choices	Parameter and Description
3	1 to 5	Central Heat Response Speed
0	0 to 30 Minutes	Central Heat Low Fire Hold Time
3	1 to 5	Domestic Heat Response Speed
0	0 to 30 Minutes	Domestic Heat Low Fire Hold Time

Hydronic System

Factory Setting	Range / Choices	Parameter and Description
Primary pump Any Demand	Never Any Demand CH, OFF DHW Demand (4" display only)	Primary pump
System Pump Any Demand	System Pump: Never System Pump: Any Demand System Pump: Central Heat, No Priority System Pump: Central Heat, Optional Priority Fresh Air Damper	Spare Output J4, 6-7
DHW Pump Primary Loop Piped IWH	DHW Pump: Never DHW Pump: Primary Loop Piped IWH DHW Pump: Boiler Piped IWH Fresh Air Damper	Spare Output J4, 6-7

Installation
Terminal Layout

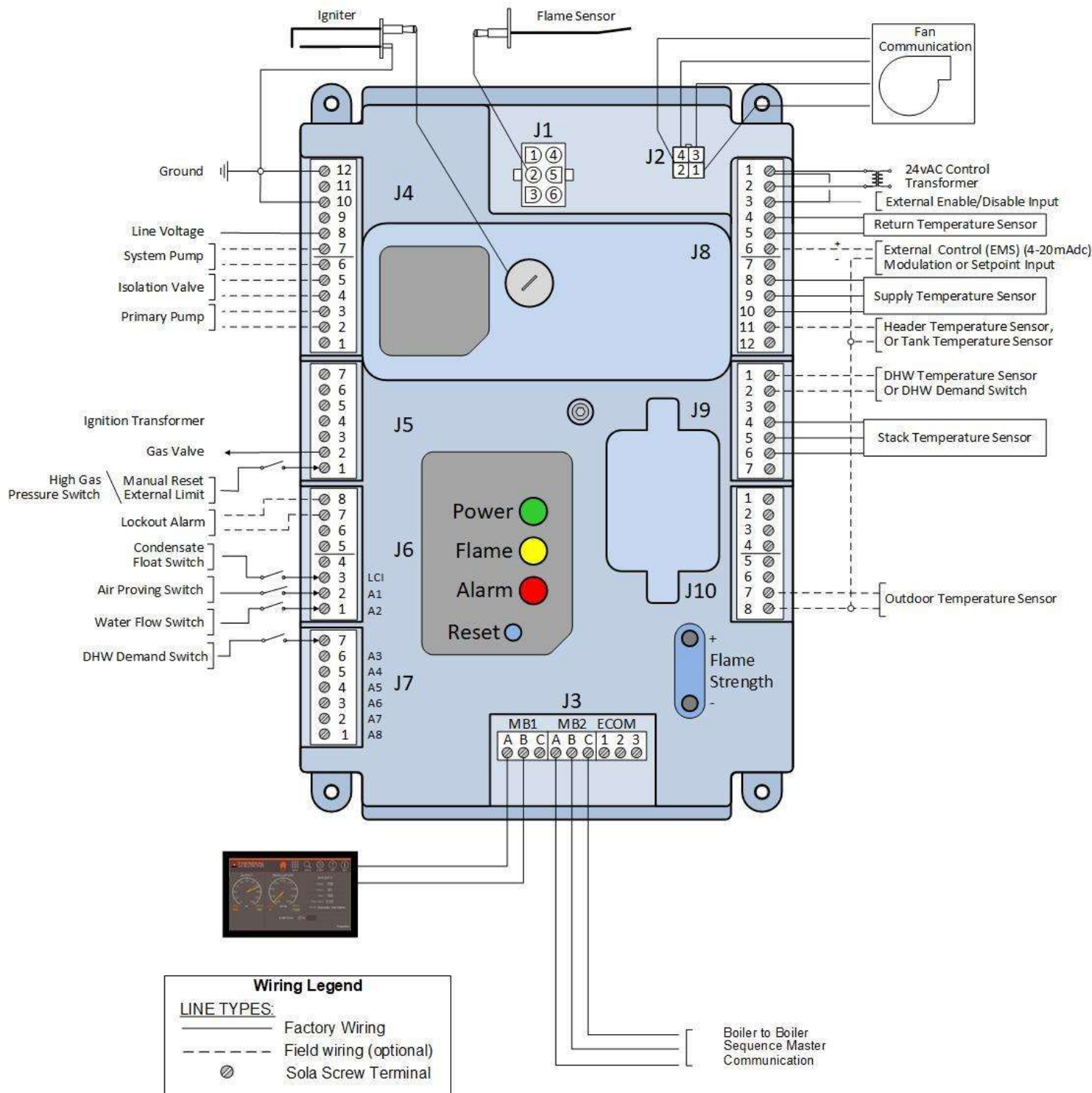

Figure 13a: Control Terminal Layout and wiring note for units less than 1000 MBH

Installation
Terminal Layout

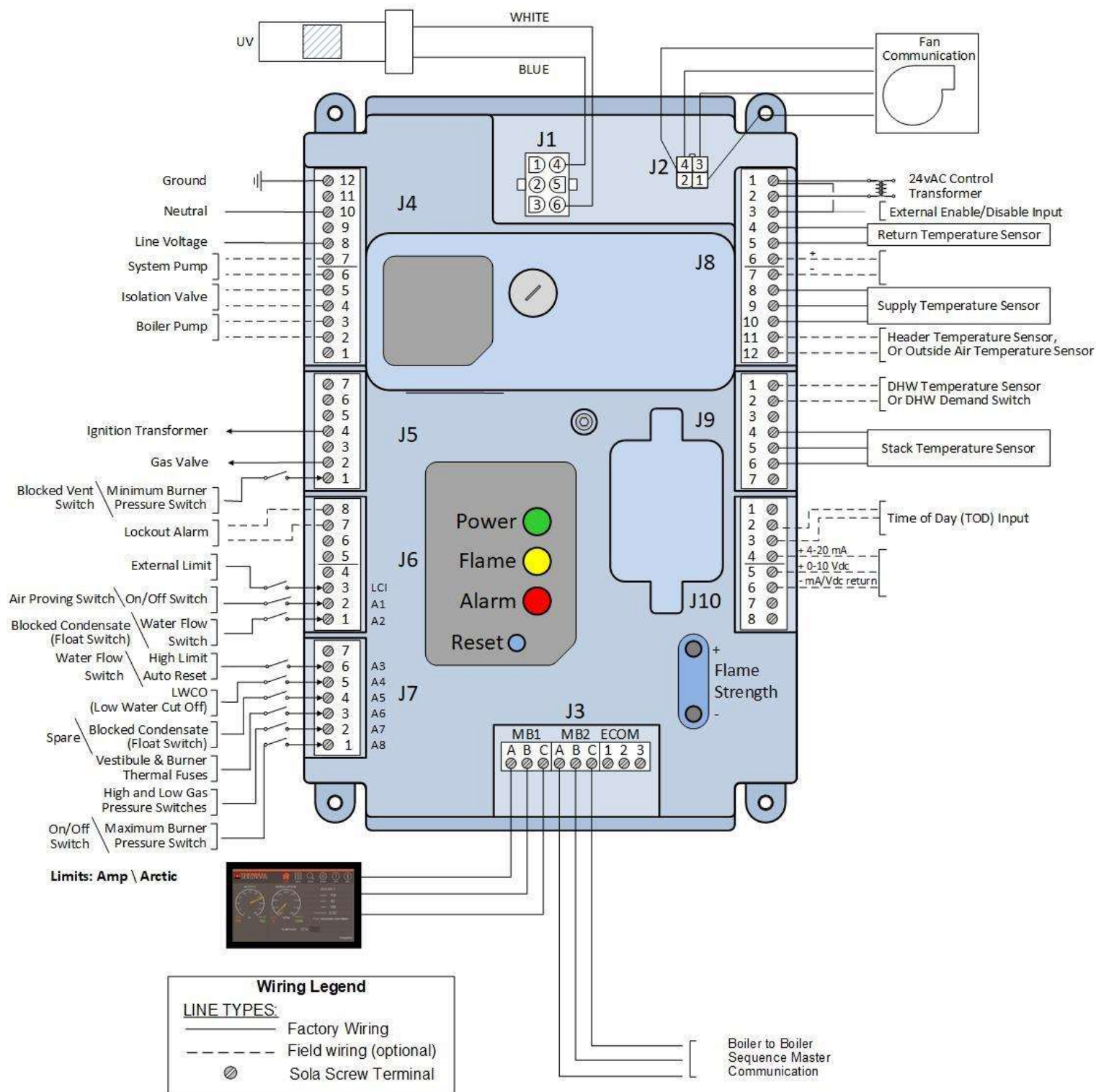

Figure 13b: Control Terminal Layout and wiring note for units greater than 1000 MBH

Installation

Terminal Layout

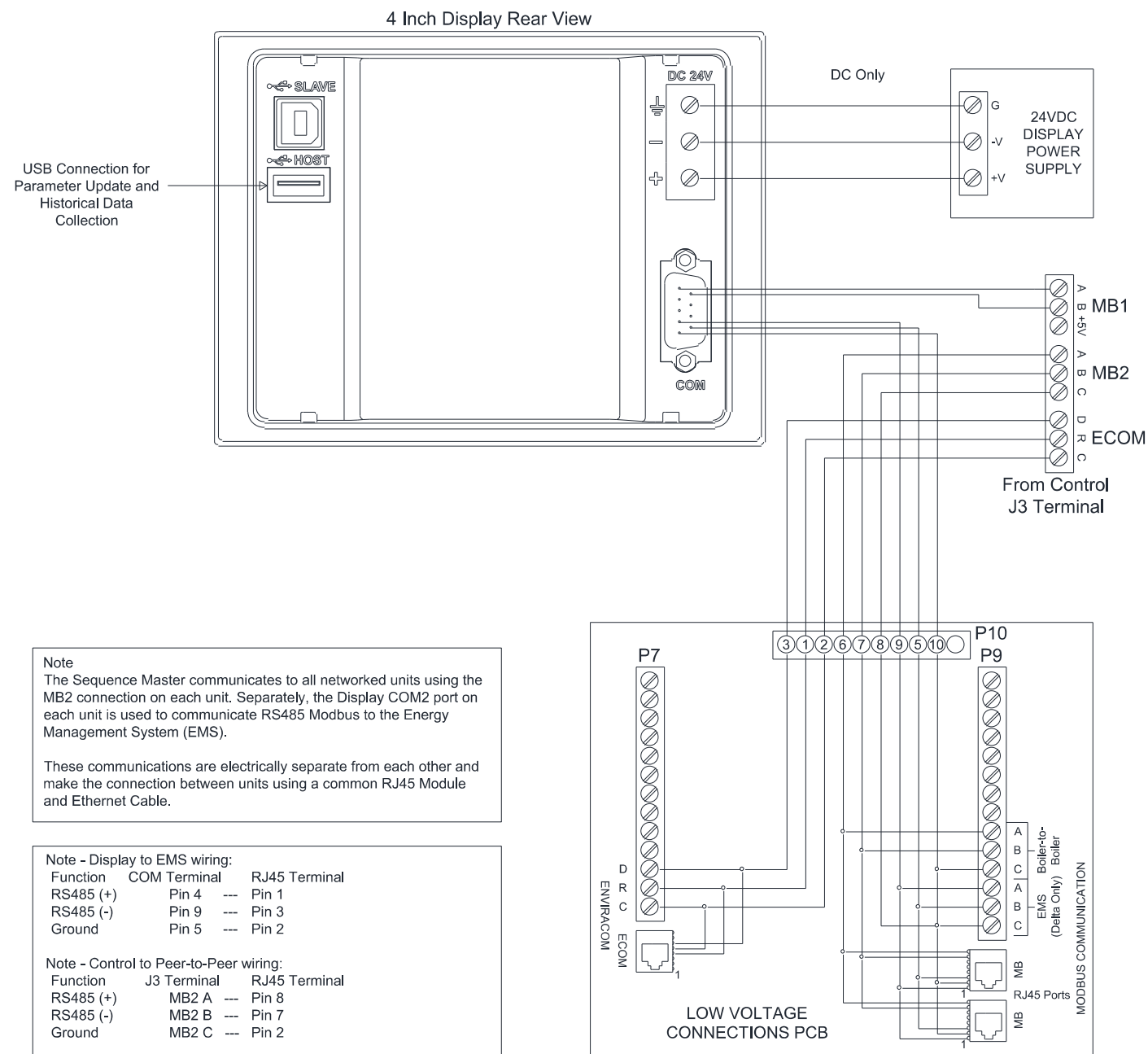

Figure 14a: Display Terminal Layout and wiring notes

Installation
Terminal Layout

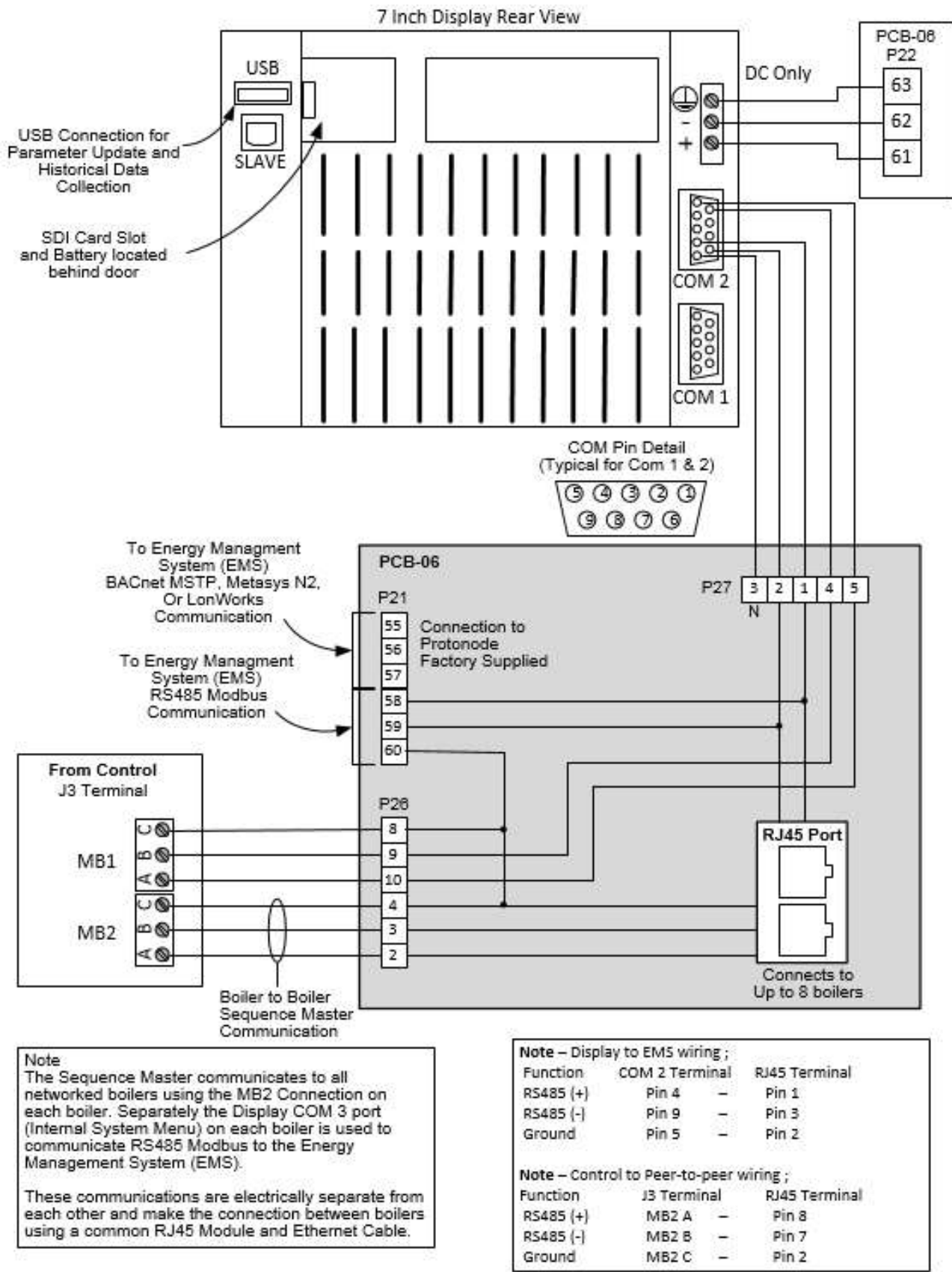

Figure 14b: Display Terminal Layout and wiring notes

Installation

Unit-To-Unit Network

The Unit-To-Unit Network allows the Control's Internal Sequence Master to communicate unit information, including modulation rate and on/off commands, using a standard Ethernet cable.

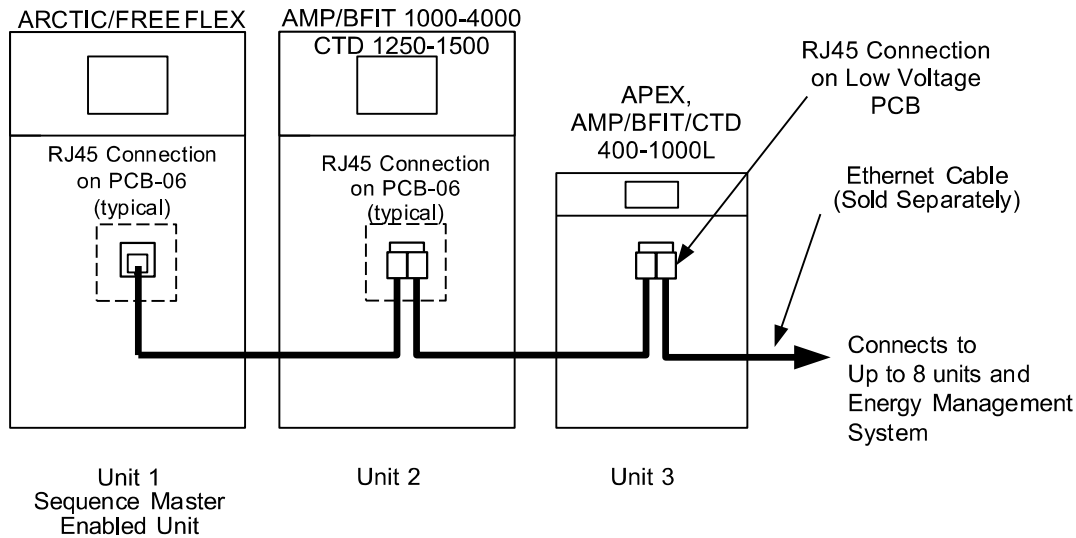

Figure 15: Communication Network Connections

Table 6: Sequence Master Setup Procedure

Step	Description	Comments
1	Install and wire the Header Sensor	<p>Wire a header sensor to Control J8 terminals 11 &12 of the Sequence Master Enabled Unit.</p> <p>NOTE</p> <p>This step cannot be skipped. The Sequence Master cannot be enabled unless a Header Sensor is installed.</p>
2	Install Ethernet Cables between units	<p>Use standard Ethernet type cables to make connection between units. When more than two units are connected an RJ45 splitter may be used to connect the units. Refer to Figure 15.</p>
4	Set Unique Unit Addresses	<p>Assign all units a unique Unit Address using any number from 1 through 8. (Found in Main Menu > Adjust > Sequence Slave)</p> <p>NOTE</p> <p>When two unit's addresses are the same undesirable simultaneous operation occurs.</p>
5	Enable 1 Unit Master	<p>Enable only one Control's Sequencer Master. (Found in Main Menu > Adjust > Sequence Master)</p> <p>WARNING</p> <p>When more than one Sequencer Master is enable erratic behavior will result.</p>
9	Confirm Communication	<p>Power down all units and power up Sequence Master Enabled unit first. From the Sequence Master Enabled Control's Home Screen "press" the Status button. The Sequencer display shows the unit address of the communicating units.</p> <p>If a unit is not shown, check Ethernet cable connections and confirm all units have unique addresses.</p>

Installation

External Sensors

Header Sensor (P/N 101935-01 or 103104-01)

A header sensor must be installed and wired to the Master Sequencer “enabled” Control. The header sensor is installed on the common system piping and provides blended temperature information to the Sequence Master. Refer to unit manual’s piping diagram for installation location and Figure 15a or 15b for installation detail.

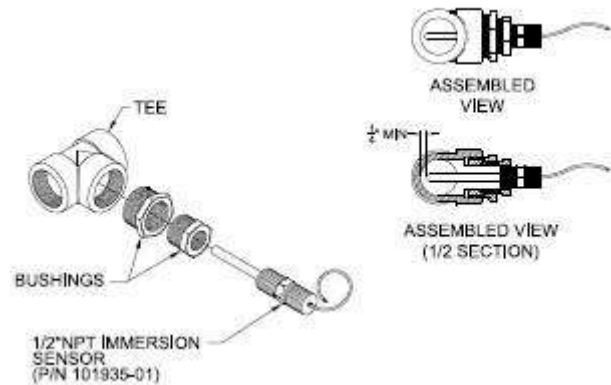

Figure 15a, Direct Immersion Type Header Sensor Installation Detail

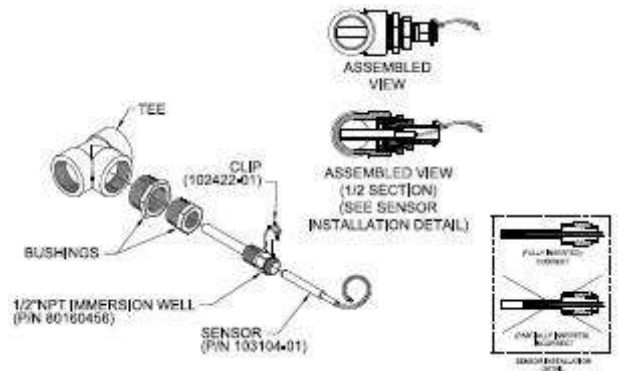

Figure 15b, Thermowell type Header Sensor Installation Detail

Installation

Energy Management Interface

The control system has a full featured ability to interface with an Energy Management System (EMS). The control system allows remote control and monitoring via RS485 Modbus or through direct wiring.



Figure 16:
Remote
Demand
Setup
Screens

(From Display “Press” Menu > EMS Interface > Remote Demand to access)

Factory Setting	Range / Choices	Parameter and Description
Local	Local, 4-20mA, Modbus	Modulation Source The unit can modulate (vary heat input) based on local or remote (4-20mA or Modbus) signals. Modulation begins after the start sequence finishes and the unit is released to modulate. Modulation Source has the following selections: Local Local setpoint and control is used to create firing rate. 4-20mA Input wired to J8 terminals 6 and 7 is used as modulation rate. Modbus Modbus signal is used as modulation rate.
Local	Local, 4-20mA, Modbus	Central Heat & Lead Lag Setpoint Source The setpoint may be based on local (customer entered value or outdoor reset) or remote (4-20mA or Modbus) signals. Setpoint Source has the following selections: Local User entered CH Setpoint or Reset Curve provides the setpoint. 4-20mA Input wired to J8 terminals 6 and 7 is used as setpoint. Modbus Modbus signal is used as setpoint.
Local	Local, Modbus	CH Demand Switch (DHW if Water Heater) The Central Heat demand (Central Heat Enable/Disable) can be directly wired to the Control or provide by the Modbus interface. Local Central Heat demand is present when a contact closure is received between J8 terminals 1 and 3 . Modbus Modbus signal provides demand.
Local	Local, Modbus	LL Demand Switch The Lead Lag Master's demand (Central Heat Enable/Disable) can be directly wired to the Control or provide by the Modbus interface. Local Lead Lag demand is present when a contact closure is received between J8 terminals 1 and 3 . Modbus Modbus signal provides demand.
130 F	50 – 185 F	4-20mAadc Setup, 4 mA Water Temperature Sets the Central Heat Temperature Setpoint corresponding to 4 mA.
180 F	50 – 185 F	Central Heat 4-20mAadc Setup 20 mA Water Temperature Sets the Central Heat Temperature Setpoint corresponding to 20mA.
1	Disable PWM to 4-20mA PWM to 0-10V LL Rate to 4-20mA LL Rate to 0-10V	Analog Rate Tracking – allows external system to monitor firing rate. Disable No signal is sent to terminals PWM to 4-20mA Firing rate provided using 4-20mA signal PWM to 0-10V Firing rate provided using 0-10V signal LL Rate to 4-20mA Sequence Master demand is provided using 4-20mA signal LL Rate to 0-10V Sequence Master demand is provided using 0-10V signal

Installation

Energy Management Interface

Remote Demand Setup Screens Continued:

Factory Setting	Range / Choices	Parameter and Description
0.1	0 – 10 tenths	Analog Input Hysteresis This parameter adjusts the amount of hysteresis applied remote control input when modulation source is set to 4-20mA. A zero value disables this feature.
1.0	0 – 40 tenths	Analog output hysteresis This parameter adjusts the amount of hysteresis applied to the PID output when a non-PWM modulation is selected. The value determines how much the PID is required to change in a new direction before the output will change. A zero value disables this feature.

Connecting a EMS Modbus Interface

Table 7: Energy Management System Interface Procedure

Step	Description	Comments
1	Install Ethernet Cables between units	Use standard Ethernet type cables to make connection between units. When more than two units are connected an RJ45 splitter may be used to connect the units. Refer to Figure 15. NOTE The same Ethernet cable that connects the Unit-To-Unit Sequence Master also connects the EMS Modbus signals. Refer to Figure 14 for detail.
2	Enable EMS Communication	Communication must be enabled. Go to Modbus menu (Press Menu > EMS Interface > Modbus Setup) and “Press” EMS Enable/Disable to Enable.
3	Set Unique Modbus Addresses “ Comm HMI Station ”	The EMS Modbus address may be independent of the Unit number or unit address. Go to Modbus menu (Press Menu > EMS Interface > Modbus Setup) and select EMS Modbus Parameters. Follow on screen instructions. NOTE Each unit must have a unique Comm HMI Station address.
4	Adjust Communication Parameters	Communication Parameters are adjustable. Go to Modbus menu (Press Menu > EMS Interface > Modbus Setup) and select EMS Modbus Parameters. Follow on screen instructions. NOTE Baud Rate and Parity must match the EMS settings for communication to be established.
9	Confirm Communication	The display provides a list of all EMS signals. Go to Modbus menu (Press Menu > EMS Interface) and select Points List. Use the list to verify signals sent and received from the EMS.

Installation

Energy Management Interface

The following Parameters are adjustable within the System menu of the display. Access System menu by going to the Main Menu > EMS Interface > Modbus Setup. Select EMS Modbus Parameters for directions on how to edit EMS Parameters. **READ ALL DIRECTIONS** before entering the System Menu.

Display Communication Port Setup:

Display Size	4in. HMI	7in. HMI	4in. HMI	7in. HMI
COM Port:	COM1	COM2	COM2	COM3
Com Port Configure For	Control		EMS	
Port Type	Modbus Master		Modbus Slave	
Special Notes	Caution Do not change any of these settings. Loss of communication to control could result.		Note This is the port to adjust settings to suit the EMS System	
Comm HMI Station This is Modbus Slave Address.	0 (not used)		1	
COM Mode	RS 485		RS 485	
Baud Rate	38400		38400	
Stop Rate	1 bit		1 bit	
Data Bits	8 bit		8 bit	
Parity	None		None	
Comm Delay	10 ms		10 ms	
Comm Timeout	1000 ms		1000 ms	
Comm Retry Times	2		2	
PLC Default Station This is address Modbus Master is reading.	1		1 (not used)	
Baud Rate Fine Tuning	0		0	

Installation

Energy Management Interface

Table 8: Modbus Signal List

The following is the list of available Modbus signals;

Register addresses start at 0 (zero) based on the Modbus-IDA protocol specification. For more traditional addressing scheme (starting at 40001) a value of 40001 should be added to the decimal address for each register. Some EMS systems may require address format "Decimal Offset" for 10,000 range registers.

Modbus Register	Protocol Name	Description	Read (R)/Write (W)
Enable / Disable			
577	Central Heat Enable/Disable	Central Heat Enable/Disable 0 = Disable 1 = Enable When this register is not written every "Modbus Command Time Out" parameter seconds (default 30 seconds), CH Modbus Stat is reverted to 0, no demand.	W
563	LLCH Modbus Stat	LL CH Modbus STAT 0 = no demand 1 = demand When this register is not written every "Modbus Command Time Out" parameter seconds (default 30 seconds), CH Modbus Stat is reverted to 0, no demand.	W
203	Burner on/off	Burner On/Off burner. 1 = on 0 = off	R
6	Demand source	0 = Unknown 1 = No source demand 2 = Central heat 3 = Domestic hot water 4 = Lead Lag slave 5 = Lead Lag master 6 = Central heat frost protection 7 = Domestic hot water frost protection 8 = No demand due to burner switch turned off 9 = Domestic hot water storage 11 = Warm weather shutdown	R
66	CH heat demand	0=Off, 1=On	R
83	DHW heat demand	0=Off, 1=On	R
123	Low Temperature Loop heat demand	0=Off, 1=On	R
Setpoints			
10,579	CH Modbus Setpoint	Use this register to change the unit setpoint. When this register is not written every "Modbus Command Time Out" parameter seconds (default 30 seconds), setpoint reverts to local setpoint valid range 60 F to 190 F	W
10,562	CH Sequencer Modbus Setpoint	Use this register to change the multiple unit Sequencer setpoint. When this register is not written every "Modbus Command Time Out" parameter seconds (default 30 seconds), setpoint reverts to local setpoint valid range 60 F to 190 F	W

Installation

Energy Management Interface

Table 8: Modbus Signal List (continued)

Modbus Register	Protocol Name	Description	Read (R)/ Write (W)
10,211	CH setpoint	Status of local setpoint	R
10,453	DHW setpoint	Status of local setpoint	R
10,546	Lead Lag setpoint	Status of local setpoint	R
10,212	CH TOD setpoint	Status of local setpoint	R
10,065	CH setpoint source	0=Unknown, 1=Normal setpoint, 2=TOD setpoint, 3=Outdoor reset, 4=Remote control (4-20mA), 7=Outdoor reset time of day	R
10,016	Active CH setpoint	-40 F (-40°C) to 266 F (130°C) Setpoint determined by CH setpoint source (register 65).	R
10,081	DHW setpoint source	0=Unknown, 1=Normal setpoint, 2=TOD setpoint, 5=DHW tap setpoint, 6=DHW preheat setpoint	R
10,017	Active DHW setpoint	-40 F (-40°C) to 266 F (130°C) Setpoint determined by DHW setpoint source (register 81).	R
10,162	Lead Lag master setpoint source	0=Unknown, 1=CH setpoint, 2=CH TOD setpoint, 3=Outdoor reset, 4=Remote control (4-20mA), 5=DHW setpoint, 6=DHW TOD setpoint, 7=Outdoor reset time of day, 8=Mix setpoint	R
10,018	Active LL setpoint	-40 F (-40°C) to 266 F (130°C) Setpoint determined by LL setpoint source (register 162).	R
10,643	Low Temperature setpoint	Setpoint entered on the local user interface. valid range 79 F (26.1 C) to 191 F (88.3 C)	R
10,121	Low Temperature setpoint source	0=Unknown, 1=Normal setpoint, 2=TOD setpoint, 3=Outdoor reset, 4=Remote control, 7=Outdoor reset time of day, 9=Outdoor boost	R
10,024	Active Low Temperature setpoint	-40 F (-40°C) to 266 F (130°C) Setpoint determined by Low Temp setpoint source (register 121).	R
Temperature Sensors			
10,007	Supply sensor	-40 F (-40°C) to 266 F (130°C)	R
10,011	Return sensor	-40 F (-40°C) to 266 F (130°C)	R
10,013	Header sensor	-40 F (-40°C) to 266 F (130°C)	R
10,014	Stack sensor	-40 F (-40°C) to 266 F (130°C)	R
10,170	Outdoor sensor	-40 F (-40°C) to 266 F (130°C)	R
15	4 - 20 mA remote control input	mA value for S2 (J8-6) parameter selectable as (remote set point) & (remote modulation)	R

Installation

Energy Management Interface

Table 8: Modbus Signal List (continued)

Modbus Register	Protocol Name	Description	Read (R)/ Write (W)
10,817	Outdoor Temperature	Building Automation may send the controller the outdoor air temperature. Use this register to change the outdoor temperature. When this register is not written every "Modbus Command Time Out" parameter seconds (default 30 seconds), temperature is set to bad data quality and outdoor air reset is set back to local setpoint. valid range -40 F to 302 F	W
Burner			
581	CH Modbus Rate	Use this register to drive individual unit firing rates. This register is used when firing rate control is performed by an external building automation system. Firing rate reverts to local control when register is not written every "Modbus Command Time Out" parameter seconds (default 30 seconds), Range is 0 to 200 % provides 0-100% firing rate.	W
8	Fan Speed Measured	Speed of the combustion air blower in rpm	R
9	Fan Speed Commanded	Speed of the combustion air blower in rpm	R
10	Flame signal	0.01V or 0.01 μ A precision (0.00-50.00V)	R
33	Burner control state	0 Initiate 1 Standby Delay 2 Standby 3 Safe Startup 4 Prepurge - Drive to Purge Rate 5 Prepurge – Measured Purge Time 6 Prepurge – Drive to Lightoff Rate 7 Preignition Test 8 Preignition Time 9 Pilot Flame Establishing Period 10 Main Flame Establishing Period 11 Direct Burner Ignition 12 Run 13 Postpurge 14 Lockout	R

Installation

Energy Management Interface

Table 8: Modbus Signal List (continued)

Modbus Register	Protocol Name	Description	Read (R)/
Trouble Shooting			
10,034	Lockout code	Reasons for burner lockout 0 No lockout, 4 Supply high limit 5 DHW high limit 6 Stack High limit 12 Flame detected out of sequence 18 Lightoff rate proving failed 19 Purge rate proving failed 20 Invalid Safety Parameters 21 Invalid Modulation Parameter 22 Safety data verification needed 23 24VAC voltage low/high 24 Fuel Valve Error 25 Hardware Fault 26 Internal Fault 27 Ignition Failure 31 Fan Failed 32 ILK ON 42 AC Phase Fault 46 Pilot Test Flame 47 Flame Lost 284 Memory Reset	R
10,040	Hold code	Reason for burner hold 0 None 1 Anti short cycle 2 Unit Safety Limit Open 3 Unit Safety Limit Open, (ILK Off) 7 Return sensor fault 8 Supply sensor fault 9 DHW sensor fault 10 Stack sensor fault 11 Ignition failure 13 Flame rod shorted to ground 14 Delta T inlet/outlet high 15 Return temp higher than supply 16 Supply temp has risen too quickly 17 Fan speed not proved 23 24VAC voltage low/high 25 Hardware Fault 27 Ignition Failure	R
Statistics			
763	Modbus command timeout	This parameter sets the amount of time the control will wait for input from the Building Automation System (BAS). If the BAS does not write to the following register within the “Modbus Command timeout” seconds the following inputs are considered invalid: CH Modbus Stat, CH Modbus Setpoint, CH Sequencer Modbus Setpoint CH Modbus Rate range 30 – 120, Default 30 seconds Other R/W registers should only be written when a value is needed to be changed. Only the above listed registers are stored in non-volatile registers.	R/W

Installation

Energy Management Interface

Table 8: Modbus Signal List (continued)

Modbus Register	Protocol Name	Description	Read (R)/ Write (W)
Pump Status			
96	CH pump status	See Table 9	R
100	DHW pump status	See Table 9	R
108	Primary pump status	See Table 9	R
128-129	Burner cycle count	0-999,999 (U32)	R/W
130-131	Burner run time	Hours (U32)	R/W
132-133	System pump cycle count	0-999,999 (U32)	R/W
134-135	DHW pump cycle count	0-999,999 (U32)	R/W
400,138-400,139	Primary pump cycle count	0-999,999 (U32)	R/W

Status	Description
92	Forced On from manual pump control
93	Forced On due to Outlet high limit is active
94	Forced On from burner demand
95	Forced On due to Lead Lag slave has demand
96	Forced Off from local DHW priority service
97	Forced Off from Lead Lag DHW priority service
98	Forced Off from Central Heat anti-condensation
99	Forced Off from DHW anti-condensation
100	Forced Off due to DHW high limit is active
101	Forced Off from EnviraCOM DHW priority service
102	On due to local CH frost protection is active
103	On due to Lead Lag CH frost protection is active
104	On due to local DHW frost protection is active
105	On due to Lead Lag DHW frost protection is active
106	On from local Central Heat demand
107	On from Lead Lag Central Heat demand
108	On from local DHW demand
109	On from Lead Lag DHW demand

Status	Description
110	On from local Mix demand
111	On from Lead Lag Mix demand
112	On from local Central Heat service
113	On from Lead Lag Central Heat service
114	On from local DHW service
115	On from Lead Lag DHW service
116	On from local Mix service
117	On from Lead Lag Mix service
118	On from Lead Lag auxiliary pump X
119	On from Lead Lag auxiliary pump Y
120	On from Lead Lag auxiliary pump Z
121	On, but inhibited by pump start delay
122	On from pump override
123	Off, not needed
124	On from burner demand
125	On from exercise
126	On from local Lead Lag service
127	On from local Lead Lag pump demand

Table 9: Pump Status Codes

Setup & Tuning

Manual Operation

The Firing rate may be adjusted manually using the Operation screen. The user may select Low or High speeds, or adjust firing rate anywhere between low and high;

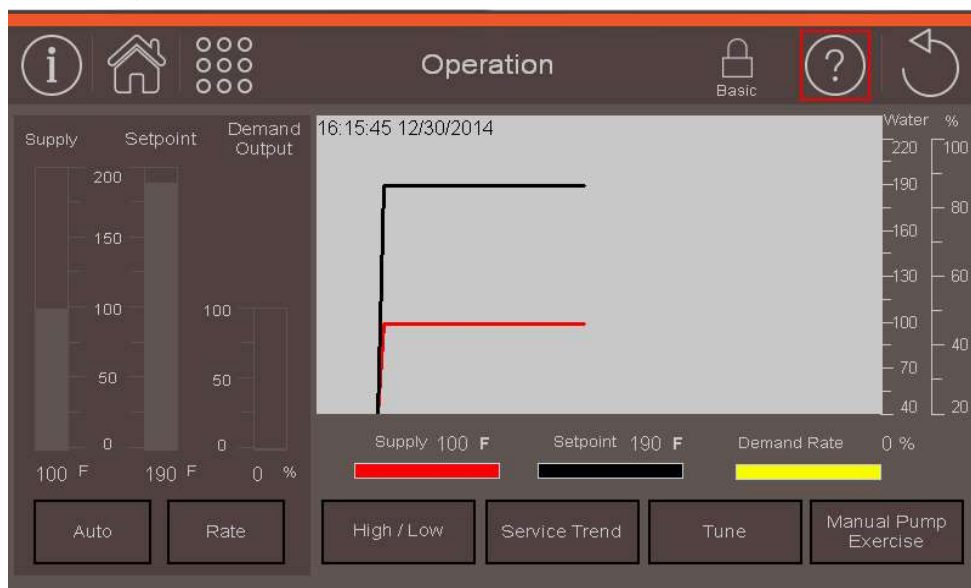

Figure 17: Operating Screens

Bar Graph & Trend

Active Sensor, Active Setpoint & Modulation

Auto/Manual

After selecting Manual Mode the User may adjust modulation manually. Menu also allows for switching of units from % (default) to RPM.

Rate

Select Manual modulation to enable user adjustment of firing rate. The factory default is Automatic mode.

High/Low

After selecting Manual Mode the High or Low buttons drives firing rate to High and Low fire position for combustion testing.

Service Trend

Service Trend screen shows; unit temps, firing rate & demand statuses.

Tune

Tune screen allows for adjustment of parameters related to the rate of unit response. This includes PID settings, Ramp rates and more. For more details on the Tune Screen see Tune Screen in Adjustable Parameters Section.

Manual Pump Exercise

Allows the pumps to be set to either ON or Automatic. When ON is selected pump will run. When Automatic is selected, pump will follow settings assigned in Pump Adjust Menu.

NOTE:

Manual control mode locks firing rate to a fixed speed. The control stays in manual even through a power cycle. Select Automatic when commissioning is complete.

Setup & Tuning

Parameter Adjustment

Login to Adjust Parameters

Control operation may be tailored to suit the application by adjusting parameters. To adjust parameters select the ADJUST icon located throughout the display.



Press ADJUST icon to review and adjust all parameters.

Parameters are password protected to discourage unauthorized or accidental changes to settings. User login is required to adjust these settings. Parameters are locked and login requirement is shown when the padlock icon is not green

- Press the Lock icon to access password screen.
- Use keypad to enter Password.
- Press Enter Key when complete.



Login is Required
Select Icon to enter password.



Select dark gray box and Enter Password
Factory = 86
Supervisor = 76

Login is Complete
Parameters may be adjusted



Figure 18: Security System

Adjusting Parameters

Editing parameters is accomplished as follows:

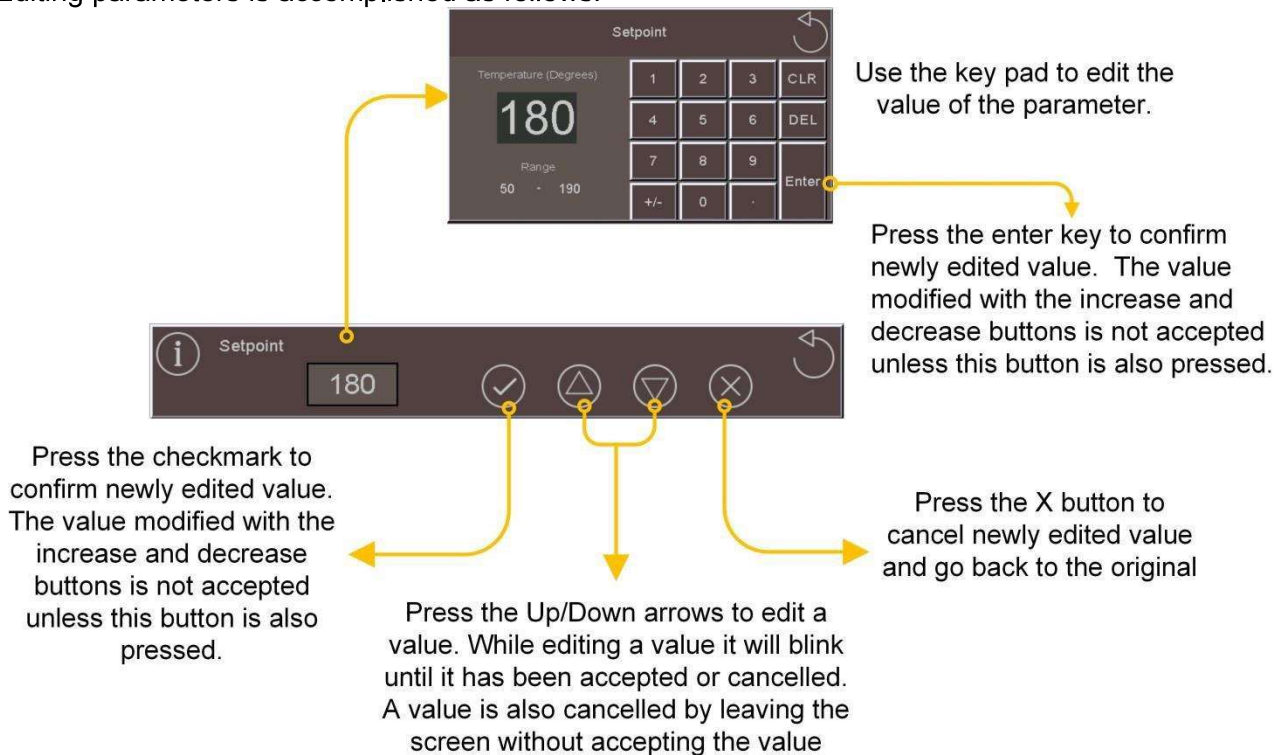

Figure 19: Adjusting Parameters

Setup & Tuning

Parameter Adjustment

From the ADJUST menu select the following buttons to view and adjust parameters.

Press **System** to adjust the following parameters.

Factory Setting	Range / Choices	Parameter and Description									
On	On/Off	Burner Enable Burner Enable is a soft switch that will prevent the unit from running without removing power from the limits. When "Off" is selected, the switch will appear on the Home screen.									
Fahrenheit	Fahrenheit Celsius	Temperature Units The Temperature Units parameter determines whether temperature is represented in units of Fahrenheit or Celsius degrees.									
Not Installed	Not Installed, Wired, Modbus, Wireless	Outdoor Sensor Source Not Installed Outdoor Sensor is not connected to the unit, the sensor is not monitored for faults. Wired Outdoor Sensor thermistor is installed directly on the unit terminal strip. Modbus Outdoor temperature is retrieved through the Modbus connection from another unit or Energy Management System. Wireless Wireless outdoor sensor is installed. Honeywell Wireless Outdoor Air Reset Adaptor part number 105766-01 is a wireless outdoor air sensor. The package includes a Wireless Receiver Module and Wireless Outdoor Sensor. The sensor communicates wirelessly to the receiver module. The receiver module is wired to the Control EnviraCOM terminals. Refer to wiring section for more information.									
0 degrees	-50 to 50 degrees	Outdoor Sensor Calibration Outdoor sensor calibration allows a single point adjustment of the outdoor sensor reading. This adjustment is a correction offset added to or subtracted from the outdoor temperature sensor reading. It is recommended to make any calibration when outdoor air temperature is at or near the most common operating point. For example, when necessary, calibrate the sensor when outdoor air is halfway between Minimum and a Maximum Outdoor Temperature parameter value is recommended.									
1 Min	0 to 20 Min	Anti-Short Cycle Time Anti-short cycle is a tool that helps prevent excessive cycling resulting from a fast cycling enable-disable input (STAT terminal). It provides a minimum delay time before the next burner cycle. DHW demand is serviced immediately, without any delay.									
Enabled	Enable/Disable	Frost Protection Disable Frost Protection is not used. Enable Unit and system circulators start and burner fires when low outside air, supply and return temperatures are sensed as follows: <table border="1"> <thead> <tr> <th>Device</th><th>Start Temperatures</th><th>Stop Temperatures</th></tr> </thead> <tbody> <tr> <td>Primary pump System Pump</td><td>Outside Air < 32°F Supply Water < 45°F</td><td>Outside Air > 36°F Supply Water > 50°F</td></tr> <tr> <td>Burner</td><td>Supply Water < 38°F</td><td>Supply Water > 50°F</td></tr> </tbody> </table>	Device	Start Temperatures	Stop Temperatures	Primary pump System Pump	Outside Air < 32°F Supply Water < 45°F	Outside Air > 36°F Supply Water > 50°F	Burner	Supply Water < 38°F	Supply Water > 50°F
Device	Start Temperatures	Stop Temperatures									
Primary pump System Pump	Outside Air < 32°F Supply Water < 45°F	Outside Air > 36°F Supply Water > 50°F									
Burner	Supply Water < 38°F	Supply Water > 50°F									
32 (°F)	-50 to 50 (°F)	Frost Protection Setpoint Outdoor Temperature at which pumps are started for frost protection.									

Setup & Tuning

Parameter Adjustment

System Menu Continued

Factory Setting	Range / Choices	Parameter and Description
76	9 Character Maximum	Supervisor Password Allows for custom password to be set. Must be 9 characters or less. Only allows adjustment of supervisor password (supervisor default: 76). Cannot change Factory password. <ul style="list-style-type: none"> • Must enter current installer password. • Must enter new password and press enter. • Must re-enter new password and press enter. <p style="text-align: right;">NOTE:</p> Can be reset to supervisor default 76 if accessed with the Factory level password (86).
Disabled	Enable/Disable	Warm Weather Shutdown Enable (Boiler Only) Disable Warm Weather Shutdown (WWSD) is not used. Enable A central heat boiler start is prevented if the outside temperature is greater than the WWSD setpoint. WWSD is initiated as soon as outside air temperature is above WWSD Setpoint. The control does not require call for heat to be satisfied before entering WWSD. The boiler will still start in response to a Domestic Hot Water call for heat.
70°F	20 to 100 (°F)	Warm Weather Shutdown Setpoint (Boiler Only) The Warm Weather Shutdown (WWSD) Setpoint used to shutdown the boiler when enabled by the "WWSD Enable" parameter.
xx/xx/xxxx	NA	System Date Date used by display Alarm History screen. A battery is provided to maintain the system date and time while the display is powered down.
xx:xx:xx	NA	System Time Time used by display Alarm History screen. A battery is provided to maintain the system date and time while the display is powered down.
Enabled	Enable/Disable	Auto Jump to Home Page Enable After 15 minutes of no use, the display will automatically return to the Home Page. Disable Display will not change screens to Home Page after 15 minutes.
Brand Dependent	Thermal Solutions, Bryan Steam	Brand Brand displayed on Home screen banner and unit model name. This can only be changed with the factory fire test password.

Setup & Tuning

Parameter Adjustment

WARNING

Asphyxiation Hazard. Unit type is factory set and must match the unit model. Only change the unit type setting if you are installing a new or replacement Control. The unit type setting determines minimum and maximum blower speeds. Incorrect unit type can cause hazardous burner conditions and improper operation that may result in PROPERTY LOSS, PHYSICAL INJURY OR DEATH.

Modulation Menu

Factory Setting	Range / Choices	Parameter and Description
Model Dependent	N/A	Unit Model Unit Size Setup To verify the unit size selection, a qualified technician should do the following: 1. Check unit's label for actual unit size. 3. Select "Confirm". The Unit Model parameter changes <u>multiple unit type related parameter</u> settings. This parameter is intended to indicate the set of default parameters and their adjustable ranges in the Control unit. <i>If the model displayed does not match the actual unit, remove the Control and install a unit with the proper configuration file. Contact the factory for necessary parts.</i> Save Modulation Settings This function stores the current modulation settings for future spare part setup operation.
	Minimum to Maximum Modulation	Central Heat Max Modulation Speed (Boiler Only) This parameter defines the highest modulation rate the Control will go to during a central heat call for heat. If the rated input of the installed radiation is less than the maximum output of the unit, change the Central Heat Maximum Modulation (fan speed) setting to limit the unit output accordingly.
100%	Minimum to Maximum Modulation"	Domestic Hot Water (DHW) Max Modulation Speed This parameter defines the highest modulation rate the Control will go to during a Domestic Hot Water call for heat. If the rated input of the indirect water heater is less than the maximum output of the unit, change the DHW Maximum Modulation (fan speed) setting to limit the unit output accordingly.
Model Dependent	Minimum + 100 to Maximum - 100	Minimum Modulation Speed This parameter is the lowest modulation rate the Control will go to during any call for heat.
	Min to Max Lightoff Rate (Model dependent)	Lightoff Rate This is the blower speed during ignition and flame stabilization periods.

NOTE: Maximum Modulation Rates are designed for 100% nameplate rate at 0°F (-18°C) combustion air. Contact factory before attempting to increase the Maximum Modulation Rate

Setup & Tuning

Parameter Adjustment

Press **Pumps** to adjust the following parameters.

Factory Setting	Range / Choices	Parameter and Description
System Pump: Any Demand	System Pump: - Never, - Any Demand, - Central Heat No Priority, - Central Heat, Optional Priority - DHW Pump	Contact A: System Pump Activates the system pump output according to selected function. Never: Pump is disabled and not shown on status screen. Any Demand: Pump Runs during any call for heat. Central Heat, No Priority: Pump Runs during central heat and frost protection call for heat. Pump <u>does not start</u> for a DHW call for heat and continues to run during Domestic Hot Water Priority. Central heat, Optional Priority: Pump Runs during central heat and frost protection call for heat. Pump <u>does not start</u> for a DHW call for heat and will be <u>forced off</u> if there is a DHW call for heat and Domestic Hot Water Priority is active. DHW Pump: Pump Runs during domestic hot water call for heat. Domestic Hot Water Priority enable/disable does not affect pump operation.
Any Demand	Never Any Demand CH, OFF DHW Demand (4" display only)	Contact B: Boiler (Primary) Pump Activates the Primary Pump, Combustion Air Damper and/or Standby Loss Damper output according to selected function: Never: Output is disabled and not shown on status screen Any Demand: Output activated for any burner demand. CH, OFF DHW Demand: Output activates during central heat and frost protection demand. Pump does not start for a DHW demand.
DHW Pump: Primary Loop Piped (IWH)	Isolation Valve: - Never, - Isolation Valve - DHW Pump	Contact C: Isolation Valve Activates the Isolation Valve or Domestic pump output according to selected function. Never: Pump is disabled and not shown on status screen. Isolation Valve: Output activated for any burner demand or when boiler is lead boiler. DHW Pump: Pump Runs during domestic hot water call for heat. Domestic Hot Water Priority enable/disable does not affect pump operation.

Setup & Tuning

Parameter Adjustment

Press **Pumps** to adjust the following parameters.

Factory Setting	Range / Choices	Parameter and Description
0 Min	0 to 60 Min	Overrun Time: System Pump Time that pump runs after demand is satisfied. Used to dissipate heat within the system.
0 Min	0 to 60 Min	Overrun Time: Isolation Valve Time that pump runs after demand is satisfied. Used to dissipate heat within the system.
1 Min	10 seconds to 60 Min	Overrun Time: Boiler (Primary) Pump (Combustion Air Damper and Standby Loss Damper) Time that pump runs after demand is satisfied. Used to dissipate heat within the system.
7 Days	0 to 40 Days	Pump Exercise Interval The number of days the pump is inactive before the pump will be activated for the Pump Exercise Time.
20 Sec	0 to 10 Min	Pump Exercise Time The amount of time the pump runs for exercise. This feature helps prevent pump seizing due to inactivity periods.

Setup & Tuning

Parameter Adjustment

Press  to adjust the following parameters.

This information may be entered from a USB thumb drive or from the screen. Refer to Using Archives section for thumb drive instructions.

Factory Setting	Parameter and Description
Enter name Enter address line 1 Enter address line 2 Enter phone number Enter email	Contractor Select the line of information to edit. Use key pad to input data and press ENT to enter data into Contractor Info.
Enter name Enter address line 1 Enter address line 2 Enter phone number Enter email	Service Company Select the line of information to edit. Use key pad to input data and press ENT to enter data into Service Company Info.
Enter name Enter address line 1 Enter address line 2 Enter phone number Enter email	Sales Representative Select the line of information to edit. Use key pad to input data and press ENT to enter data into Sales Representative Info.

Setup & Tuning

Parameter Adjustment

		Slower Response ← → Faster Response						
Faster Response ↑ ↓ Slower Response	Gain (P)	Integral (I) Repeats/Minute					CH & DHW Response Speed Settings	Sequence Master Response Speed Settings
		0.5	1.0	2.0	3	4		
	103	17	35.0	70	105.0	140		
	89	15	30.0	60	90.0	120		
	74	12	25.0	50	75.0	100		
	59	10	20.0	40	60.0	80		
	44	8	15.0	30	45.0	60		
	30	5	10.0	20	30.0	40		
	26	5	9.0	18	27.0	36		
	22	4	7.5	15	22.5	30		
	19	3	6.5	13	19.5	26		
	15	3	5.0	10	15.0	20		
	11	2	4.0	8	12.0	16		
	9	2	3.0	6	9.0	12		
	7	1	2.5	5	7.5	10		
	6	1	2.0	4	6.0	8		
							5: P=59, I=40	5: P=30, I=10
							4: P=50, I=10	4: P=29, I=9
							3: P=44, I=45	3: P=22, I=7
							2: P=30, I=30	2: P=19, I=6
							1: P=30, I=20	1: P=15, I=5

Table 11: Response Speed Adjustment Guidelines

Press **Central Heat** to adjust the following parameters. **BOILER ONLY**

Factory Setting	Range / Choices	Parameter and Description
180	50 to 190 (°F)	Central Heat Setpoint Target temperature for the central heat priority. Value also used by the outdoor air reset function.
170 (°F)	50 to 190 (°F)	Central Heat Time of Day (TOD) Setback Setpoint The TOD setpoint is used when a time of day timer relay is wired to the Time Of Day Controller Input. When setback is "on" the time of day setback setpoint shifts the reset curve to save energy while building is in a reduced room temperature mode. The reset curve is shifted by the difference between the High Boiler Water Temperature and the TOD Setback Setpoint. Any time of day timer may be used to provide the input to the control TOD input. When connected, it allows boiler water setback cost savings.
10 (°F)	3 to 29 (°F)	Central Heat Difference Above The boiler stops when the water temperature rises 'Difference Above' degrees above the setpoint.
5 (°F)	3 to 29 (°F)	Central Heat Heat Diff Below The boiler starts when the water temperature drops 'Difference Below' degrees below the setpoint.
3	1 to 5	Central Heat Response Speed This parameter adjusts the Central Heat temperature controller Proportion Integral Derivative (PID) values. Higher values cause a larger firing rate change for each degree of temperature change. If set too high firing rate "overshoots" required value, increases to high fire causing the temperature to exceed the "Difference Above" setpoint and cycle the boiler unnecessarily. Lower values cause a smaller firing rate change for each degree of temperature change. If set too low, the firing rate response will be sluggish and temperature will wander away from setpoint. Refer to Table 11 for PID values used by these selections.

Setup & Tuning

Parameter Adjustment

Factory Setting	Range / Choices	Parameter and Description
Outlet Sensor	Outlet Sensor Header Sensor	Central Heat Modulation Sensor Heat Demand may respond to the boiler's Supply Temperature or Header Temperature sensors. When Header Sensor is selected the boiler is fired in response to the sensor wired to Header Sensor terminal J8 terminals 11 and 12. NOTE: Outdoor air sensor cannot be selected to use the same terminal.
0 Min	0 to 30 Min	Central Heat Low Fire Hold Time "Low Fire Hold Time" is the number of seconds the control will wait at low fire modulation rate before being released to modulate. After ignition and flame stabilization periods the firing rate is held at low fire for "Low Fire Hold Time". This delay allows heat to travel out to the system and provide system feedback prior to the control modulating firing rate.
1200 RPM	1200 to 1300 RPM	Central Heat Low Fire Hold Rate "Low Fire Hold Rate" is the modulation rate the boiler will fire at for the duration of the "Low Fire Hold Time" before being released to modulate. After ignition and flame stabilization periods the firing rate is held at "Low Fire Hold Rate" for "Low Fire Hold Time". This delay allows heat to travel out to the system and provide system feedback prior to the control modulating firing rate.

Press **Domestic Hot Water** to adjust the following parameters.

Factory Setting	Range / Choices	Parameter and Description
0 Min	0 to 90 Min	Domestic Hot Water Priority Time When Priority Time is greater than zero and Domestic Hot Water (DHW) heat demand is "on" the DHW demand will take "Priority" over space heating demand. When the System and Primary pumps are configured as "Central Heat (off DHW priority)" or "Central Heat, Optional Priority" then they will be forced "off" during Priority Time. Priority Time provides "Priority Protection" time for the event of a failed or excessive long DHW demand. "Priority Time" is the time that the priority of the unit will shift away from Central Heat to satisfy a Domestic Hot Water call for heat.
180	50 to 190 (°F)	Domestic Hot Water Setpoint The Domestic Hot Water (DHW) Setpoint parameter is used to create a unit water temperature setpoint that is used when DHW heat demand is "on". When the DHW heat demand is not "on" (the contact is open or <u>not wired</u>) this setpoint is ignored
170 (°F)	50 to 190 (°F)	Domestic Hot Water Time of Day (TOD) Setback Setpoint The TOD setpoint is used when a time of day timer relay is wired to the Time Of Day Controller Input. When setback is "on" the time of day setback setpoint shifts the DHW setpoint to lower the DHW temperature and to save energy while building is in a reduced room temperature mode.
10 (°F)	3 to 29 (°F)	Domestic Hot Water Difference Above The unit stops when the water temperature rises 'Difference Above' degrees above the setpoint.
5 (°F)	3 to 29 (°F)	Domestic Hot Water Diff Below The unit starts when the water temperature drops 'Difference Below' degrees below the setpoint.

Setup & Tuning

Parameter Adjustment

Factory Setting	Range / Choices	Parameter and Description
3	1 to 5	Domestic Hot Water Response Speed This parameter adjusts the Domestic Hot Water temperature controller Proportion Integral Derivative (PID) values. Higher values cause a larger firing rate change for each degree of temperature change. If set too high firing rate “overshoots” required value, increases to high fire causing the temperature to exceed the “Difference Above” setpoint and cycle the unit unnecessarily. Lower values cause a smaller firing rate change for each degree of temperature change. If set too low, the firing rate response will be sluggish and temperature will wander away from setpoint. Refer to Table 11 for PID values used by these selections.
0 Min	0 to 30 Min	Domestic Hot Water Low Fire Hold Time “Low Fire Hold Time” is the number of minutes the control will wait at low fire modulation rate before being released to modulate. After ignition and flame stabilization periods the firing rate is held at low fire for “Low Fire Hold Time”. This delay allows heat to travel out to the system and provide system feedback prior to the control modulating firing rate.
1200 RPM	1200 to 1300 RPM	Domestic Hot Water Low Fire Hold Rate “Low Fire Hold Rate” is the modulation rate the unit will fire at for the duration of the “Low Fire Hold Time” before being released to modulate. After ignition and flame stabilization periods the firing rate is held at “Low Fire Hold Rate” for “Low Fire Hold Time”. This delay allows heat to travel out to the system and provide system feedback prior to the control modulating firing rate.
Demand: DHW Switch Modulation: Outlet Sensor	Demand: DHW Switch Modulation: Outlet Sensor Demand: DHW Sensor Modulation: DHW Sensor	Domestic Hot Water Demand/Modulation Domestic Hot Water Demand may respond to the unit's DHW Switch or DHW Sensor. When “DHW Switch/Outlet Sensor” is selected the unit responds to a domestic hot water demand when a DHW Switch is sensed at J9 terminal 1 & 2 and is fired in response to the Outlet Sensor. When “DHW Sensor/DHW Sensor” is selected the unit responds to a domestic hot water demand when the DHW Sensor, temperature measured at J9 terminal 1 & 2 is below the “DHW Setpoint” less “Difference Below” and is fired in response to the DHW Sensor.

Press

Outdoor Reset

 to adjust the following parameters. **BOILER ONLY**

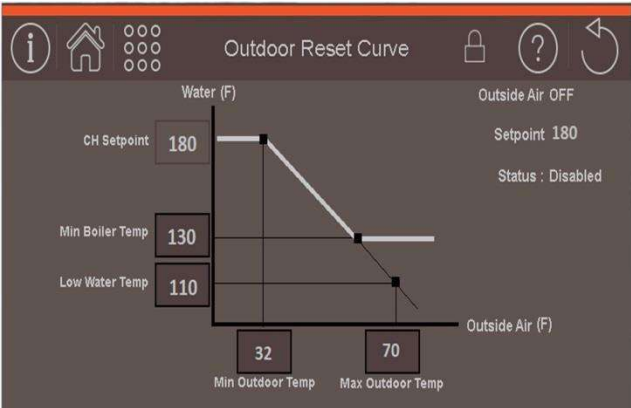

Figure 20:
Reset Curve

Setup & Tuning

Parameter Adjustment

Factory Setting	Range / Choices	Parameter and Description
Disabled	Enable Disable	<p>Outdoor Reset Enable If an outdoor sensor is installed and Outdoor Reset is Enabled, the boiler will automatically adjust the heating set point temperature based on the outdoor reset curve in (see Figure 20). The maximum set point is defined by the Central Heat Setpoint (default 180 F) when the outdoor temperature is Min Outdoor Temp (default 32 F) or below. The minimum set point temperature shown is 130°F when the outdoor temperature is 50°F or above. As the outdoor temperature falls the supply water target temperature increases.</p> <p>Disable <u>Do Not</u> Calculate setpoint based on outdoor temperature Enable Calculate the temperature setpoint based on outdoor temperature using a reset curve defined by Low Outdoor Temp, High Outdoor Temp, Low Boiler Water Temp, Min Boiler Temp and Central Heat Setpoint and Boost Time parameters.</p>
30 (°F)	-50 to 32 (°F)	<p>Minimum Outdoor Temperature The Low Outdoor Temperature parameter is also called “Outdoor Design Temperature”. This parameter is the outdoor temperature used in the heat loss calculation. It is typically set to the coldest outdoor temperature.</p>
70 (°F)	35 to 100 (°F)	<p>Maximum Outdoor Temperature The High Outdoor Temperature parameter is the outdoor temperature at which the Low Boiler Water Temperature is supplied. This parameter is typically set to the desired building temperature.</p>
110 (°F)	70 to 180 (°F)	<p>Low Water Temperature The Low Boiler Water Temperature parameter is the operating setpoint when the High Outdoor Temperature is measured. If the occupied space feels cool during warm outdoor conditions, the Low Boiler Water Temperature parameter should be increased.</p>
130 (°F)	50 to 185 (°F)	<p>Minimum Boiler Water Temperature The Minimum Boiler Temperature parameter sets a low limit for the Reset setpoint. Set this parameter to the lowest supply water temperature that will provide enough heat for the type radiation used to function properly. Always consider the type of radiation when adjusting this parameter.</p>
0 Min	0 to 30 Min	<p>Boost Time When the Central Heat Setpoint is decreased by Outdoor Reset settings, the Boost Time parameter is used to increase the operating setpoint when the space heat demand is not satisfied after the Boost Time setting is exceeded. When heat demand has been “on” continuously for longer than the Boost Time parameter the operating setpoint is increased by 10°F (5.6°C). The highest operating setpoint from Boost Time is current Central Heat Setpoint minus the Central Heat “Diff Above” setting. A setting of 0 seconds disables this feature.</p>
187 (°F)	50 to 190 (°F)	<p>Central Heat Outdoor Air Maximum Off Point Maximum value the setpoint can reach due to boost function. Should be set to match Central Heat Setpoint.</p>
187 (°F)	50 to 190 (°F)	<p>Lead Lag Outdoor Air Maximum Off Point Maximum value the setpoint can reach due to boost function. Should be set to match Central Heat Setpoint.</p>

Setup & Tuning

Parameter Adjustment

Press **Sequence Master** to adjust the following parameters.

Factory Setting	Range / Choices	Parameter and Description
Disabled	Enable Disable	Master Enable/Disable The Sequencer Master Enable/Disable is used to “turn on” the Multiple Unit Lead-Lag Control. WARNING: Enable ONLY one Sequence Master in the unit-to-unit network.
Boiler Piped	Boiler Piped Primary Piped	Indirect Water Heater (IWH) (Boiler Only) Boiler Piped Sequencer to respond to an Isolated DHW demand that is piped to a single boiler. The individual boiler goes on “Leave” from the Sequencer Master and goes to DHW Service. Primary Piped The Sequence Master responds to the DHW Call For Heat. This allows one or more boilers to provide heat to the IWH.
Disabled	Enable Disable	DHW Two Boiler Start (Boiler Only) The Sequencer to immediately start two boilers for a DHW call for heat. Used when DHW is the largest demand. Only relevant when “Primary Piped IWH” is selected.
3 Min	0.5 to 20 Min	Boiler Start Delay Slave boiler time delay after header temperature has dropped below the setpoint minus “Difference below”. Longer time delay will prevent nuisance starts due to short temperature swings.
1 Min	0.5 to 5 Min	Boiler Stop Delay Slave boiler time delay after header temperature has risen above the setpoint plus “Difference Above” setpoint. Longer time delay will prevent nuisance stops due to short temperature swings.
195 (°F)	50 to 195 (°F)	Stop All Units Setpoint When this temperature is reached all Networked boilers are stopped at once without any stop boiler time delays. This setpoint allows the Sequencer to respond to rapid load increases.
40%	25 to 100 %	Base Load Common Rate To maximize condensing boiler efficiency, the firing rate is limited to an adjustable value. Boilers are kept at or below this firing rate as long as the boilers can handle the load. After last available boiler has started, the modulation rate limit is released up to 100%.
24 Hours	8 to 48 Hours	Lead Rotation Time Time boilers will act as the lead before switching the lead to another boiler in the boiler to boiler network.
3	1 to 5	Response Speed This parameter adjusts the Central Heat temperature controller Proportion Integral Derivative (PID) values. Higher values cause a larger firing rate change for each degree of temperature change. If set too high firing rate “overshoots” required value, increases to high fire causing the temperature to exceed the “Difference Above” setpoint and cycle the boiler unnecessarily. Lower values cause a smaller firing rate change for each degree of temperature change. If set too low, the firing rate response will be sluggish and temperature will wander away from setpoint. Refer to Table 11 for PID values used by these selections.

Setup & Tuning

Parameter Adjustment

Press **Slave Sequencer** to adjust the following parameters.

Factory Setting	Range / Choices	Parameter and Description
None	1 to 8	Modbus Address Each unit must be given a unique address. When “Normal” slave selection order is used, the Modbus address is used by the Sequence Master as the boiler start order.
Normal	First Normal Last	Slave Selection Order “Use First”; Places the Slave in the lead permanently. “Use Last”; Places the slave last in the firing order.

Press **Limits** to adjust the following parameters.

Factory Setting	Range / Choices	Parameter and Description
11 (°F)	(Stepped Modulation Recycle Offset + 6) to 30	Stepped Modulation Start Offset Stepped Modulation is provided to help the boiler continue to supply heat when temperatures are beginning to approach Limits. This feature helps avoid manual reset and soft lockouts by reducing the firing rate when the temperature is “Stepped Modulation Start Offset” degrees below the Limit setting. For example, when the setting is 11 F the maximum modulation rate will begin to be reduced when stack temperature is 11 F below the Stack Limit and will be at minimum modulation when stack temperature is 5 F below the limit. Supply Temperature (High Limit 210 F)(see Note below), Differential Temperature (Differential Temperature Limit 100 F), Stack Temperature (Stack Limit 230 F), Note: This feature is not active for Supply temperature when it is the modulation sensor. For example, this feature is active when Header Sensor is selected as modulation sensor, when a boiler is a slave, when a boiler is responding to a remote modulation demand (4-20mAdc or Modbus).
5 (°F)	0 to (Stepped Modulation Start Offset – 6)	Stepped Modulation Recycle Offset This feature helps avoid manual reset and soft lockouts by recycling the boiler when the temperature is “Stepped Modulation Recycle Offset” degrees below the Limit setting. For example, when the setting is 5 F the boiler will recycle when supply temperature is 5 F below the High Limit. Applicable to the following measurements. Supply Temperature (High Limit 210 F)(see Note below), Differential Temperature (Differential Temperature Limit 100 F), Stack Temperature (Stack Limit 230 F), Note: This feature is not active for Supply temperature when it is the modulation sensor. For example, this feature is active when Header Sensor is selected as modulation sensor, when a boiler is a slave, when a boiler is responding to a remote
200 (°F)	60 to 200 (°F)	Preferred Supply High Limit Adjustable high limit for the supply temperature. Only adjustable to a number below the maximum High Limit in the control.
230 (°F)	150 to 230 (°F)	Preferred Stack High Limit Adjustable high limit for the stack temperature. Only adjustable to a number below the maximum Stack Limit in the control.

Setup & Tuning

Press Tune to access the following menus.



Press Central Heat Tuning within the Tune menu to adjust the following parameters. **BOILER ONLY**

Factory Setting	Range / Choices	Parameter and Description
4	1 to 5	Response Speed This parameter adjusts the Central Heat temperature controller Proportion Integral Derivative (PID) values. Higher values cause a larger firing rate change for each degree of temperature change. If set too high firing rate “overshoots” required value, increases to high fire causing the temperature to exceed the “Difference Above” setpoint and cycle the boiler unnecessarily. Lower values cause a smaller firing rate change for each degree of temperature change. If set too low, the firing rate response will be sluggish and temperature will wander away from setpoint. Refer to Table 11 for PID values used by these selections.
50	0 to 400	Proportional Rate Proportional Gain value for Central Heat control modes. A larger gain value results in tighter, more active, PID control. Gain is the primary PID modulation rate tuning adjustment and provides the immediate modulation rate response. Pick a gain based on the desired initial response. The burner modulation rate can oscillate if the Proportional Gain is too large.
10	0 to 400	Integral Rate Integral gain value For Central Heat control Modes. A larger value makes the Integral ramp in less time (i.e., faster). Integral is a secondary PID modulation rate tuning adjustment that ramps the output over time (typically minutes). Based on the selected Local PID P, select the corresponding (from above table) Integral value. Repeats per minute between 0.5 and 2.0 are typical. The burner modulation rate can oscillate if the Integral time is too large.
0 min	0 to 30 min	Central Heat Low Fire Hold Time “Low Fire Hold Time” is the number of seconds the control will wait at low fire modulation rate before being released to modulate. After ignition and flame stabilization periods the firing rate is held at low fire for “Low Fire Hold Time”. This delay allows heat to travel out to the system and provide system feedback prior to the control modulating firing rate.
1200 RPM	1200 to 1300 RPM	Central Heat Low Fire Hold Rate “Low Fire Hold Rate” is the modulation rate the unit will fire at for the duration of the “Low Fire Hold Time” before being released to modulate. After ignition and flame stabilization periods the firing rate is held at “Low Fire Hold Rate” for “Low Fire Hold Time”. This delay allows heat to travel out to the system and provide system feedback prior to the control modulating firing rate.

Setup & Tuning

Press

Domestic Hot Water
Tuning

within the Tune menu to adjust the following parameters

Factory Setting	Range / Choices	Parameter and Description
3	1 to 5	Response Speed This parameter adjusts the Domestic Hot Water temperature controller Proportion Integral Derivative (PID) values. Higher values cause a larger firing rate change for each degree of temperature change. If set too high firing rate “overshoots” required value, increases to high fire causing the temperature to exceed the “Diff Above” setpoint and cycle the unit unnecessarily. Lower values cause a smaller firing rate change for each degree of temperature change. If set too low, the firing rate response will be sluggish and temperature will wander away from setpoint.
44	0 to 400	Proportional Rate Proportional Gain value for Domestic Hot Water control modes. A larger gain value results in tighter, more active, PID control. Gain is the primary PID modulation rate tuning adjustment and provides the immediate modulation rate response. Pick a gain based on the desired initial response. The burner modulation rate can oscillate if the Proportional Gain is too large.
45	0 to 400	Integral Rate Integral gain value For Domestic Hot Water control Modes. A larger value makes the Integral ramp in less time (i.e., faster). Integral is a secondary PID modulation rate tuning adjustment that ramps the output over time (typically minutes). Based on the selected Local PID P, select the corresponding (from above table) Integral value. Repeats per minute between 0.5 and 2.0 are typical. The burner modulation rate can oscillate if the Integral time is too large.
0 min	0 to 30 min	Domestic Hot Water Low Fire Hold Time “Low Fire Hold Time” is the number of minutes the control will wait at low fire modulation rate before being released to modulate. After ignition and flame stabilization periods the firing rate is held at low fire for “Low Fire Hold Time”. This delay allows heat to travel out to the system and provide system feedback prior to the control modulating firing rate.
1200 RPM	1200 to 1300 RPM	Domestic Hot Water Low Fire Hold Rate “Low Fire Hold Rate” is the modulation rate the unit will fire at for the duration of the “Low Fire Hold Time” before being released to modulate. After ignition and flame stabilization periods the firing rate is held at “Low Fire Hold Rate” for “Low Fire Hold Time”. This delay allows heat to travel out to the system and provide system feedback prior to the control modulating firing rate.

Setup & Tuning

Press

Sequencer
Tuning

within the Tune menu to adjust the following parameters

Factory Setting	Range / Choices	Parameter and Description
3	1 to 5	Response Speed This parameter adjusts the Sequence Master temperature controller Proportion Integral Derivative (PID) values. Higher values cause a larger firing rate change for each degree of temperature change. If set too high firing rate “overshoots” required value, increases to high fire causing the temperature to exceed the “Diff Above” setpoint and cycle the unit unnecessarily. Lower values cause a smaller firing rate change for each degree of temperature change. If set too low, the firing rate response will be sluggish and temperature will wander away from setpoint.
22	0 to 400	Proportional Rate Proportional Gain value for Sequencer control modes. A larger gain value results in tighter, more active, PID control. Gain is the primary PID modulation rate tuning adjustment and provides the immediate modulation rate response. Pick a gain based on the desired initial response. The burner modulation rate can oscillate if the Proportional Gain is too large.
7	0 to 400	Integral Rate Integral gain value For Sequencer control Modes. A larger value makes the Integral ramp in less time (i.e., faster). Integral is a secondary PID modulation rate tuning adjustment that ramps the output over time (typically minutes). Based on the selected Local PID P, select the corresponding (from above table) Integral value. Repeats per minute between 0.5 and 2.0 are typical. The burner modulation rate can oscillate if the Integral time is too large.

Setup & Tuning

Press **Fan Tuning** within the Tune menu to adjust the following parameters

Factory Setting	Range / Choices	Parameter and Description
500 rpm/sec.	0 to 12000	Fan Speed-Up Ramp Whenever the burner is firing it will be commanded to increase its RPM no faster than the rate provided by this parameter. This is a maximum speed limit.
500 rpm/sec.	0 to 12000	Fan Speed-Down Ramp Whenever the burner is firing it will be commanded to decrease its RPM no faster than the rate provided by this parameter.
15	1 to 100	Fan Gain Up This is the gain for speeding up the fan.
8	1 to 100	Fan Gain Down This is the gain for slowing down the fan.
Disabled	Enable Disable	CH Slow Start Enable/Disable (Boiler Only) This parameter enables or disables the slow start limit function for Central Heat and Sequence Master demand sources. It uses the CH Low Fire Hold Rate parameter as the starting point for the slow start.
Disabled	Enable Disable	DHW Slow Start Enable/Disable This parameter enables or disables the slow start limit function for DHW demand source. It uses the DHW Low Fire Hold Rate parameter as the starting point for the slow start.
20 degrees	0 to 180	Slow Start Degrees If slow start limiting is enabled and the supply temperature is less than the temperature provided by subtracting this number of degrees from the setpoint, then slow start rate limiting is effective. Whenever the supply temperature is above this value, slow start limiting has no effect.
200 %/min.	0 to 1000	Slow Start Ramp When slow start limiting is in effect, the modulation rate will increase no more than the amount per minute given by this parameter. Although provided as a per-minute value, the Control will calculate and apply this as a stepped function using step duration of 10 seconds.

Troubleshooting

General Issues

WARNING

Electrical Shock Hazard. Turn off power to unit before working on wiring. This unit must only be serviced by skilled and experienced service technician.

Troubleshooting when “Help” icon



NOT flashing;

Indication	Condition	Possible Cause
Unit not responding to call for heat, “Status” and “Priority” show “Standby”.	Demand Not Detected	Unit is not seeing Enable/Disable of Domestic Demand Input. Check wiring loose connection, miswiring. If Domestic Demand is expected check that DHW Demand/ Modulation is selected properly.
Unit not responding to a call for heat, “Status” shows “Standby” and “Priority” shows Central Heat or Domestic Hot Water.	Pumps Running and Unit is not Running	Unit is not firing, temperature is greater than setpoint. Select display Help icon and review Limit String Status.
Unit Running but System or Unit Circulator is not running	Pumps Not Running	<ul style="list-style-type: none"> Check wiring for loose connection, miswiring. When there is a Domestic Hot Water Heat Request the System or Primary pumps will be forced “off” when there “Run Pump for” parameter is set to “Central heat, off DHW demand” or “Central Heat, Optional Priority”. This has been set to allow all of the heat to be provided for fast indirect water heater recovery. After “priority protection” time or the end of the Domestic Hot Water Heat Request the system and primary pumps will be free to run.
Display Completely Dark Fan off, LWCO lights off, no green power light on Control	No 120Vac Power at Unit	<ul style="list-style-type: none"> Check breaker and wiring between breaker and unit. Blown high voltage fuse or breaker tripped.
Display Completely Dark, Fan running	No 24Vac Power to Control No 24 Vdc to Display	<ul style="list-style-type: none"> Loose 120Vac connection wiring between unit J-Box and transformer or 24 Vdc power supply. Loose 24 Vac wiring connection between transformer and Control. Blown low voltage fuse or transformer blown. Bad transformer or bad 24 Vdc power supply.
Blinking Green power light on Control	Control Fault	The green light is connected to internal power supply. The power supply is repeatedly starting and stopping (not normal) making the light flash. The microprocessors are not running. Try disconnecting all terminals except 24VAC to power the Control. The green light should be steady. If it is not, then the control is defective. If steady, start plugging in all the connectors while watching the green light. When faulty wiring reconnected, green light will begin to flash.

Troubleshooting

General Issues (continued)

Faults are investigated by selecting the “Help” button from the “Home” screen. When a fault is active the “Help” button flashes red. Continue selecting the flashing buttons to be directed to the Fault cause.

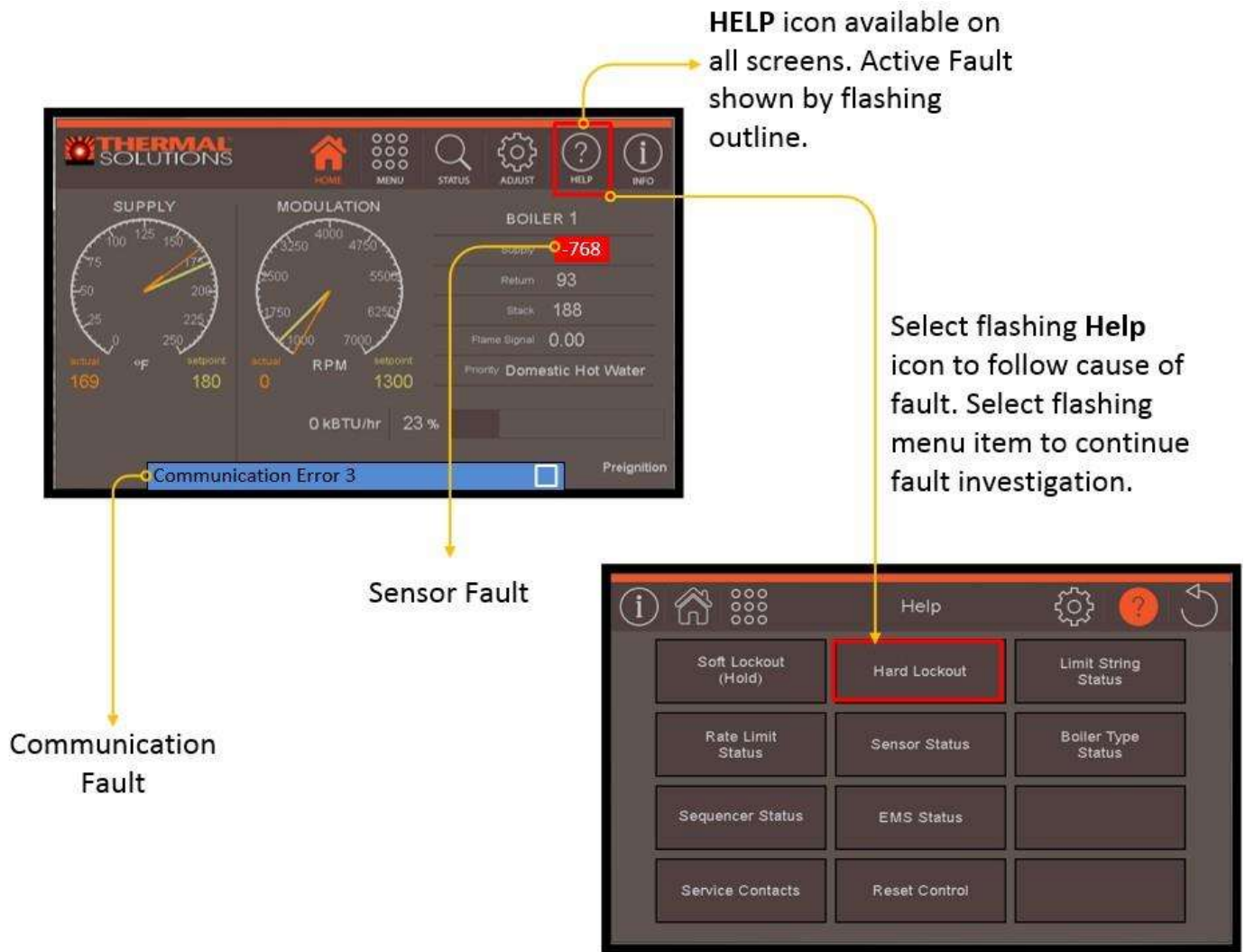
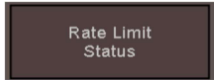
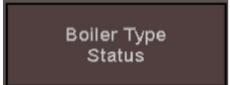
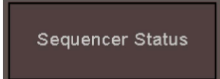

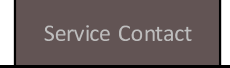



Figure 21: General Alarms

Indication	Condition	Possible Cause
Blank Screen with “Reading” shown	Display lost communication with control	Failure to establish Communication upon display boot-up once you establish communication, reboot display to read controller and setup display properly.
Communication Error 2	Communication Fault	The display write attempt has failed. Possible causes are that the password level is too low for the parameter being changed, the controller is un-configured, or has a memory failure. Lockout 20 Safety Data Verification will be displayed if control is not configured or has had a memory loss. In this case replace control.
Communication Error 3	Communication Fault	Display has lost communication with controller. <ul style="list-style-type: none"> - Loose or defective display harness - Defective Display - Defective Control - Incorrect Communication Parameters (See page 22)

Troubleshooting

General Issues (continued)

Flashing Red Outline	Condition	Possible Cause
	Rate Limit Status	<p>The following messages appear when the firing rate is limited or reduced to help avoid unnecessary cycling or lockout. Refer to Soft and Hard Lockout sections for potential corrective action.</p> <ul style="list-style-type: none"> - High Stack Temperature Rate Limit (Temp > 210 F) - High Supply Temperature Rate Limit (Temp > 190 F) - High Differential Temperature Rate Limit (Delta T > 80 F) - Minimum Modulate (normal start/stop sequence) - Forced Modulation (normal start/stop sequence) - Burner Control Rate (normal start/stop sequence) - Manual Firing Rate (User selection) - Low Fire Hold (user selection)
	Unit Size Fault	<p>WARNING!</p> <p>Unit size setting may not match actual unit size.</p> <p>The Unit size setting determines min, max and light-off blower speeds. Incorrect unit size can cause hazardous burner conditions and improper operation that may result in PROPERTY LOSS, PHYSICAL INJURY, OR DEATH.</p>
	Sequencer Fault	<p>This alarm is active if the slave unit has lost communication with the Sequence Master. Check the following:</p> <ul style="list-style-type: none"> - RJ 45 peer-to-peer network disconnected - Sequencer Master was Enabled and then Disabled - Master's Unit has been powered down. - To clear fault restore communication or cycle power
	EMS Status	This alarm is active if there is a fault with the Energy Management System (EMS) interface. Signals received from the EMS are listed with selection status and present value.
	Service Contact	The user is given the contact information of the responsible installing contractor, service company, representative and manufacturer. Refer to page 35 for data entry instructions
	Reset Control	When the lockout condition has been cleared, manual reset hard Lockouts maybe reset here or on the top of the control.

Troubleshooting

Sensors Status

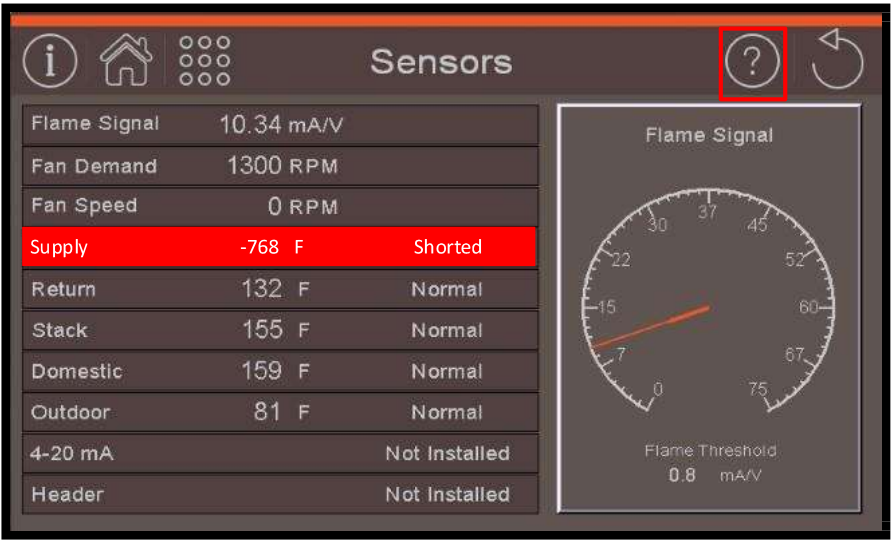

Figure 22: Sensor Screen shown with Shorted Supply Sensor

The sensor status screen is selected from the **MAIN** or **HELP** menus. A failed sensor is shown with a red background. By selecting on the individual sensors a larger display “gauge” with applicable limits is provided. When a sensor fails “opened” or “shorted” the value is changed to reverse video (background red and value black) and shows “024” or “768” respectively to indicate that there is a fault with the sensor.

Each Sensor is provided with the following diagnostic information:

Indication	Possible Cause
Not Installed	The sensor has not been selected. As shown in Figure 22 above, the Header sensor has not been selected. Refer to the Parameter Adjustment section for additional information.
Open	Check sensor wiring. Sensor open will show if the sensor has not yet been wired to the unit or if a wire is loose.
Shorted	Check sensor wiring. Sensor terminals are connected to each other or the sensor has failed.
Outside low range Outside high range	Sensor input is out of range. Sensor is defective or is being subjected to electrical noise.
Not reliable	Sensor is unreliable. Sensor is defective or is being subjected to electrical noise.

Troubleshooting

Limit String

The Limit String Status screen shows the safety limit status. A contact icon, either “ON” or “OFF”, graphically represents each safety limit. The “ON” contact icon with normal text; the “OFF” contact icon is shown in red. “ON” means that the contact is closed and there is no issue. An “OFF” limit means the contact is open and the limit is not “made”.

Limit String Status screen (Figure 23) shows unit limits in order, 120 Vac positive to neutral. When a limit is “OFF”, all other contacts below (or “downstream”) that limit will also show as “OFF”. When troubleshooting, **the first Limit in the string of “OFF” Limits is the contact to inspect.**



Figure 23: Limit String Status

“ON” limits indicating the limits are closed.

“OFF” limits indicating the limits are open. In this case the contact at A6 (ILK) Thermal Fuse Limit is open. The status of limits downstream is unknown.

NOTE: Some Limits cycle normally based on the function of the unit. For example, the Low Air Pressure limit will cycle to “OFF” after the unit post purge is complete. The “Help” icon only indicates a fault (flashes) when the limit string is not behaving normally.

Troubleshooting

Soft Lockouts (Holds)

Display Faults

When a soft lockout occurs, the unit will shut down and the “Help” button will “blink”. Select the “blinking” “Help” button to determine the cause of the soft lockout. The unit will automatically restart once the condition that caused the lockout is corrected.

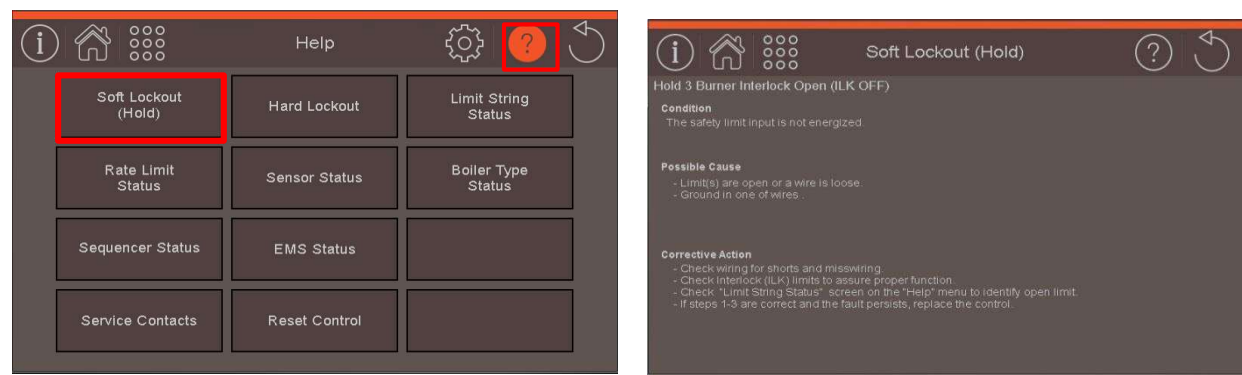

Figure 24: Soft Lockout Example

The Soft Lockout screen will display the Hold number, name of the Hold, the condition that caused the Hold, possible causes, and a basic description of corrective actions that may be taken to fix the problem.

Below is an in-depth guide to all possible lockouts.

Lockout Number	Condition	Possible Cause
1 Anti-Short Cycle	Minimum time between starts has not been reached. Normal delay used to avoid excessive cycles.	- Faulty contact provided by the EMS system.
2 Unit Recycling Limits Open (LCI OFF)	The LCI input is not energized.	- Limit Control Input (LCI) is not 'ON'. Refer to limit string screen for list of limits. - A wire is loose.
3 Unit Safety Limit Open	Unit Safety Limit Interlock (ILK) is OFF.	- Lockout input (ILK) is not 'ON'. Refer to limit string screen for list of limits. - Loose wiring to limit device. - Jumper not installed.
7 Return sensor fault	Shorted or open return temperature sensor.	- Shorted or miswired return sensor wiring. - Defective return sensor.
8 Supply sensor fault	Shorted or open supply temperature sensor.	- Shorted or miswired supply sensor wiring. - Defective supply sensor.
9 DHW sensor fault	Shorted or open Domestic Hot Water (DHW) temperature sensor.	- Shorted or miswired DHW sensor wiring. - Defective DHW sensor.
10 Stack sensor fault	Shorted or open flue gas (stack) temperature sensor.	- Shorted or miswired flue temperature sensor wiring. - Defective flue temperature sensor.

Troubleshooting

Soft Lockouts (Holds) Continued

Lockout Number	Condition	Possible Cause
13 Flame rod shorted to ground	Flame rod shorted to ground	<ul style="list-style-type: none"> - Shorted or miswired flame rod wiring. - Defective flame rod.
14 Delta T inlet/outlet high	Temperature rise between supply and return is too high.	<ul style="list-style-type: none"> - Inadequate unit water flow. Verify that circulator is operating and that circulator and piping are sized per Installation Instructions Manual, Water Piping and Trim Section.
15 Return temp higher than supply	The Control is reading a return sensor temperature higher than the supply sensor temperature. Condition must be present for at least 75 seconds for this error code to appear.	<ul style="list-style-type: none"> - Flow through unit reversed. Verify correct piping and circulator orientation. - No unit water flow. Verify that system is purged of air and that appropriate valves are open. - Sensor wiring reversed. - Supply or return sensor defective.
16 Supply temp has risen too quickly	Supply water temperature has risen too quickly.	<ul style="list-style-type: none"> - See possible causes for "Hard Lockout 4". - Inadequate unit water flow. - Verify that circulator is operating and that circulator and piping are sized per Installation Instructions Manual, Water Piping and Trim Section.
17 Blower speed not proved	Normal waiting for blower speed to match purge and light-off setpoint.	-
27 Interrupted Airflow Switch On	Interrupted Airflow Switch Failed in closed position	<ul style="list-style-type: none"> - The air proving switch has failed on, check switch is operating properly
27 or 28 Interrupted Airflow Switch Off	Interrupted Airflow Switch Failed to Close	<ul style="list-style-type: none"> - The air proving switch has failed to close; - Check switch, check switch connection and wiring. - Blocked vent, blocked inlet, blocked or disconnected inlet air switch tube, blocked heat exchanger or burner. - Something is blocking air/flue gas flow through unit

Troubleshooting

Hard Lockouts

Display Faults

When a fault is active the “Help” button flashes red. The “Help” button will lead you to the Help menu, which will flash to indicate the issue with the unit. If “Hard Lockout” is flashing select that button to investigate further.

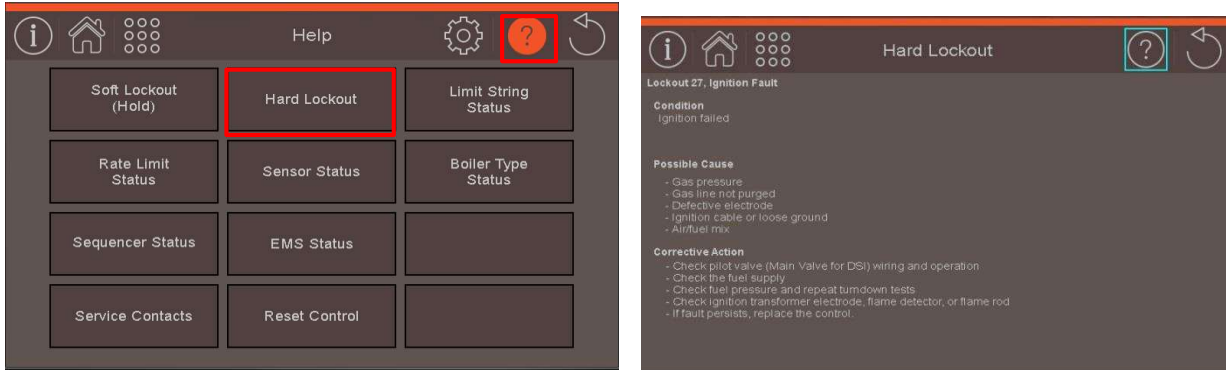

Figure 25: Hard Lockout Example

The Hard Lockout screen will display the Lockout number, name of the lockout, the condition that caused the lockout, possible causes, and a basic description of corrective actions that may be taken to fix the problem.

Below is an in-depth guide to all possible lockouts.

Lockout Number	Condition	Possible Cause
3 Burner Interlock Open (ILK OFF)	The safety limit input is not energized.	<ul style="list-style-type: none">- Limit(s) are open or a wire is loose.- Ground in one of the wires.
4 Supply high limit	Supply sensor detected temperatures exceeding High Limit.	<ul style="list-style-type: none">- Heating load at time of error was far below the minimum firing rate of the unit.- Defective system circulator or no flow in primary loop.- Defective unit circulator, no flow or insufficient flow in unit loop.- Control system miswired so that the unit operation is permitted when no zones are calling.
5 DHW high limit	DHW sensor detected temperatures in excess of Setpoint.	<ul style="list-style-type: none">- DHW load at time of error was far below the minimum firing rate of the unit.- Control system miswired so that unit operation is permitted when no DHW are calling.
6 Stack High limit	Flue gas (Stack) sensor detected temperatures in excess of 204°F (95.6°C).	<ul style="list-style-type: none">- Heat exchanger needs to be cleaned.- Unit over-fired.- Air-fuel mixture out of adjustment - consult factory.
12 Flame detected out of sequence	A flame signal was present when there should be no flame.	<ul style="list-style-type: none">- Defective gas valve - make sure inlet pressure is below maximum on rating plate before replacing valve.

Troubleshooting

Hard Lockouts (continued)

Lockout Number	Condition	Possible Cause
14 Delta T Inlet/Outlet High	The difference between the inlet/return and the outlet/supply temperature is too large.	<ul style="list-style-type: none"> - Inadequate unit water flow
15 Return Temp Higher Than Supply	The temperature of the return/inlet is higher than the temperature of the supply/outlet	<ul style="list-style-type: none"> - Water flow reversed - No flow, sensor reversed, sensor bad
16 Supply Temp Risen Too Quickly	The supply/outlet temperature has risen too quickly.	<ul style="list-style-type: none"> - Water flow reversed - No flow, sensor reversed, sensor bad
18 Light off rate proving failed	Blower is not running at Light-off rate when it should or blower speed signal not being detected	<ul style="list-style-type: none"> - Heating load far below min - Bad pump or low primary flow - Unit on with no zones on
19 Purge rate proving failed	Blower is not running at Purge rate when it should or blower speed signal not being detected	<ul style="list-style-type: none"> - Loose connection in 120 VAC blower wiring. - Loose or miswired blower speed harness. - Defective blower
20 Configuration Fault	Unacceptable Control Safety related parameter detected. (See display for details)	<ul style="list-style-type: none"> - Safety Parameter verification required. Contact factory.
21 Invalid Modulation Parameter	Unacceptable Control Modulation related parameter detected.	<ul style="list-style-type: none"> - Reset the control.
22 Safety data verification needed	Safety related parameter change has been detected and verification has not been completed.	<ul style="list-style-type: none"> - Safety related Control parameter has been changed and verification has not been performed.
23 24VAC voltage low/high	Control 24Vac control power is high or low.	<ul style="list-style-type: none"> - Loose connection in 24Vac VAC power wiring. - Loose or miswired 24Vac harness. - Miswired wiring harness causing power supply short to ground. - Defective transformer. - Transformer frequency, voltage and VA do not meet specifications.
24 Fuel Valve Error	Power detected at fuel valve output when fuel valve should be off.	<ul style="list-style-type: none"> - Loose or defective gas valve harness. Check electrical connections. - Defective gas valve (check for 24 Vac at harness during trial for ignition before replacing valve).
25 Hardware Fault	Internal control failure. (See display for details)	<ul style="list-style-type: none"> - Reset the control. If problem reoccurs, replace the Control.
26 Internal Fault	Internal control failure.	<ul style="list-style-type: none"> - Reset the control. If problem reoccurs, replace the Control.

Troubleshooting

Hard Lockouts (continued)

Lockout Number	Condition	Possible Cause
27 Ignition failure	Flame failure	<ul style="list-style-type: none"> - No gas pressure. - Gas pressure under minimum value shown on rating plate. - Gas line not completely purged of air. - Defective Electrode. - Loose burner ground connection. - Defective Ignition Cable. - Defective gas valve (check for 24 Vac at harness during trial for ignition before replacing valve). - Air-fuel mixture out of adjustment - consult factory.
27 Pre-Ignition Interlock (PII) OFF	Pre-Ignition Interlock Open	<ul style="list-style-type: none"> - Open or loose limit
27 Interrupted Airflow Switch (IAS) OFF	Interrupted Airflow Switch Open	<ul style="list-style-type: none"> - Airflow too low - Defective switch
27 Interrupted Airflow Switch (IAS) ON	Interrupted Airflow Switch Closed	<ul style="list-style-type: none"> - Unexpected airflow - Defective switch - Miswired
27 High Fire Switch Fault	High Fire Switch Closed	<ul style="list-style-type: none"> - Miswired - Defective switch
31 Fan Failed	Fan speed failed	<ul style="list-style-type: none"> - Miswired - VFD failed to check speed
32 ILK ON	This lockout occurs when the interlock string is closed before the blower starts. The airflow switch is the only device in the interlock string that will open when in standby.	<ul style="list-style-type: none"> - Air pressure in the unit room has become negative. - Excessive downdraft in the stack. - Blower is spinning before being commanded by the hydronic control. Make sure blower is not running in standby. - Airflow switch is stuck closed.
42 AC Phase Fault	AC inputs phase reversed	<ul style="list-style-type: none"> - Check the control and display connection. - Check the control power supply and make sure that both frequency and voltage meet the specs - Ensure 24 Vac is functioning properly
46 Pilot Test Flame	Pilot Test Flame Timeout	<ul style="list-style-type: none"> - Pilot test flame timed out. Reset the control to restart.
47 Flame Lost	Flame lost in MFEP	<ul style="list-style-type: none"> - Pilot Valve (main Valve for DSI) - Fuel Supply - No gas pressure, Gas pressure under minimum value shown on rating plate, Gas line not purged - Defective flame sensor - Loose ground - Air/fuel mix out of adjustment
	Flame Lost early in RUN	
	Flam Lost in RUN	
284 Memory Reset To Default	OEM Memory Lost, Honeywell Default Memory Restored	<ul style="list-style-type: none"> - Controller Failure - Consult Factory - Replace Control

Trouble Shooting

Using Archives

The archives are a fundamental resource for the users interested in commissioning, optimizing and trouble-shooting an issue with the unit. Using the archives a user may review up to 4 months of sensor values, up to 3000 alarms, lockout history or cycle and run history. Data may be simply viewed on screen or exported to a thumb drive for detailed analysis.



Supply/Return Temperature History / Flame Intensity History / Fan Rate History

Supply, Return, flame and fan data provides an opportunity to investigate issues, learn about system operation or fine tune the unit. Values are stored on the display for up to 4 months. Data may be easily backed up to a thumb drive. Historical data values are viewed by scrolling left and right, the further left, the older the data. By touching the trend at any location, the exact data points will display as well as the Date and Time at which they were recorded.



Touch at any point in the graph to show the exact data, and Time and Date it was taken at.

Lockout History

Lockout History is stored in a first-in, first-out basis. Each lockout file is stored with unit run hour of when the lockout occurred, status at the time of the lockout, and the Annunciator in the limit string that caused the lockout (Only if applicable to that lockout). Up to 15 lockouts may be stored in the Lockout History, 1 being the newest. Touching the lockout shows more information about the lockout that occurred.

A screenshot of the 'Lockout History' table. The table has columns for 'No.', 'Lockout', 'Description', '1st Annunciator Out', 'Run Hour', and 'Status During'. The data is as follows:

No.	Lockout	Description	1st Annunciator Out	Run Hour	Status During
3	Boiler Safety Limit Open			51	
27	Lockout 27: Touch here for details			51	Over-temperature
4	Outdoor Air High Limit			50	Warning
32	Run On			50	Warning
3	Boiler Safety Limit Open	A1: Blocked Condensate		50	Warning

Touch any Lockout to see more information about it.

Cycle & Run Time History

Cycle and Run time data is provided for control, unit and pumps. Additionally, a load profile is collected. Graphs are provided that show amount of time the unit operated at each load point. Data may be reset.

A screenshot of the 'Cycle & Run Time History' table. The table has columns for 'Parameter' and 'Value'. The data is as follows:

Parameter	Value
Controller Cycle Count	361
Controller Run Time	83 Hrs
Burner Cycle Count	275
CHW Pump Cycle Count	69
Burner Run Time	53 Hrs
Boiler Pump Cycle Count	112
System Pump Cycle Count	150
CHW Load Graph Samples	0
CH Load Graph Samples	21

Touch the parameter to clear the current count.

Trouble Shooting

Using Archives

Alarm History

The alarm history is a powerful tool that will record up to 3000 alarms. These alarms include **Lockouts, Holds, Sensor Faults, EMS Communication Error or Loss, Unit-to-Unit Network Communication Loss, 4-20mA Errors, and Limit String Cycling.**

The alarms are recorded in a list with the most recent appearing at the bottom. The alarm list can be scrolled through to investigate past alarms and most current alarms. The alarms are given a date and time stamp which allows for better troubleshooting capability. The alarm list may be downloaded to a USB in the form of a spreadsheet by using the **Save to Historical Data** function in the **Archives Menu.**

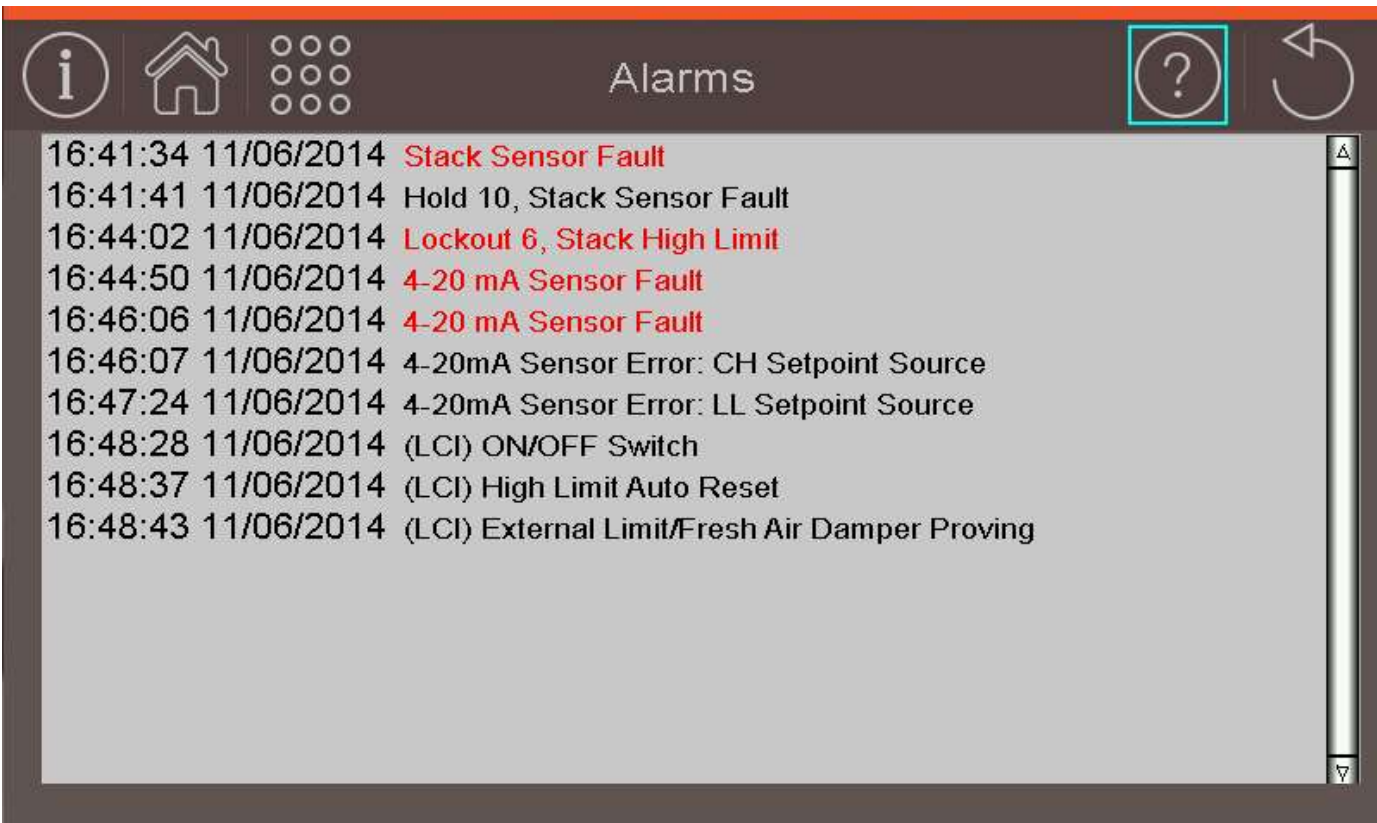

Trouble Shooting

Using Archives

USB Thumb Drive Requirements

The Thumb Drive **must** be formatted as a FAT32 for use with the display. In order to check the format of a USB Thumb Drive, follow these instructions:

- Plug the USB Drive into a computer
- Ensure that the USB Drive does not have anything currently saved on it.
- Go to My Computer (Select Start > Computer)
- Right click on the “Removable Disk” and select Properties
- Under the “General” tab confirm “File system: FAT32”
- If it does not say FAT32, close window, return to My Computer
- Right Click on the “Removable Disk” and select Format
- Select File system = FAT32
- Select Start and then select OK to format the USB Thumb Drive.
- The USB Thumb Drive is now FAT32 format

Save Historical Data

“Save Historical Data” will save historical parameter data and the current alarm list as spreadsheets to the USB Drive that is plugged into the Unit Display. The files will have a date code in the file name, year/month/date, of when they were saved from the unit. That CSV files will be saved to the USB thumb drive under the following path:

My Computer > Removable Disk (USB Drive) > HMI > HMI000 > @HMI0001 > CSV

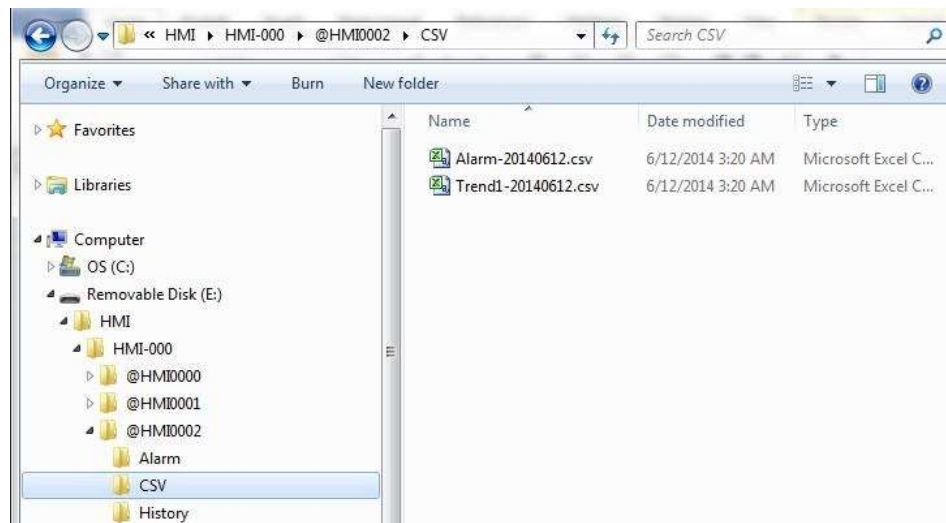

NOTE: @HMI0001 is newer than @HMI0000. If another set of historical data is saved from the display, the new file will be saved as @HMI0002. The highest number is the newest data.

NOTE: Trend1-20140612.csv & Alarm20140612 are the names of the files that saved from the unit in the example above. The 20140612 is the date code of whenever the data was retrieved from the unit. In the example shown it was the year 2014, the 6th month of the year, 12th day of that month.

Trouble Shooting

Using Archives

An example of the **Trend1-20141022.csv** file follows:

Supply, Return, Header, & Stack are all sensor data.

Setpoint is the active setpoint of the boiler at time data was taken.

Fan speed and Fan Demand show the modulation of the boiler.

Flame Signal is in shown mA/V and should have the form 00.00. (eg. At time 20:19:55 above it is 12.39)

CH Demand & DHW Demand show what demands were active at what time. 1 = Demand 0 = No demand.

Boiler State is the current status of the boiler the list of boiler states can be found in Table 12

Outdoor Temp is sensor data. (-32256 value indicates no sensor data)

		SUPPLY	RETURN	HEADER	STACK	SETPOINT	FAN SPEED	FAN DEMAND	FLAME SIGNAL	CH DEMAND	DHW DEMAND	BOILER STATE	OUTDOOR TEMP
20:13:38	10/15/2014	120	100	117	78	179	5650	5650	0	1	0	12	-32256
20:14:39	10/15/2014	125	101	117	78	179	5650	5650	0	1	0	12	-32256
20:15:40	10/15/2014	130	101	117	78	179	5650	5650	0	1	0	12	-32256
20:18:54	10/15/2014	133	101	117	78	179	5650	5650	1238	1	0	12	-32256
20:19:55	10/15/2014	136	101	117	78	179	5650	5651	1239	1	0	12	-32256
20:20:55	10/15/2014	140	101	117	78	179	5650	5651	1239	1	0	12	-32256
20:21:56	10/15/2014	145	101	117	78	179	5650	5651	1235	1	0	12	-32256

Table 12, Unit State

Unit State	#
Initiate	0
Standby delay	1
Standby	2
Safe Startup	3
Drive Purge	4
Prepurge	5
Drive Lightoff	6
Preignition Test	7
Preignition	8
PFEP	9
MFEP	10
Direct Ignition	11
Running	12
Postpurge	13
Lockout	14

Trouble Shooting

Using Archives

An example of the **Alarm-20141022.csv** file follows:

Date and Time of alarm occurrence



10/16/2014	23:48:49	O	(LCI) ON/OFF Switch
10/16/2014	23:48:52	X	(LCI) ON/OFF Switch
10/21/2014	21:18:59	O	Hold 14, Delta T Inlet/Outlet High
10/21/2014	21:19:08	O	(LCI) ON/OFF Switch
10/21/2014	21:19:11	X	(LCI) ON/OFF Switch
10/21/2014	21:19:25	X	Hold 14, Delta T Inlet/Outlet High
10/21/2014	21:19:45	O	Lockout 4, Outlet/Supply High Limit
10/21/2014	21:20:18	X	Lockout 4, Outlet/Supply High Limit
10/21/2014	21:23:49	O	Lockout 4, Outlet/Supply High Limit
10/21/2014	21:24:13	X	Lockout 4, Outlet/Supply High Limit
10/21/2014	21:24:29	O	Lockout 4, Outlet/Supply High Limit
10/21/2014	21:24:33	X	Lockout 4, Outlet/Supply High Limit
10/21/2014	21:24:45	O	Lockout 4, Outlet/Supply High Limit

O means the alarm was tripped.
X means the alarm was cleared.

The alarm list is organized so that the newest alarms are at the bottom.

Save Parameters to USB

“Save Parameters” saves the current parameter settings of the unit, including the contact information of the contractor, Service Company, and sales representative, to a USB Drive. This allows for easy transfer of unit parameters from one unit to another. Refer to parameter summary for list of parameters.

Instructions for Save Parameters:

1. Plug USB thumb drive into USB Port on Unit
2. Select Main Menu > Archives > Save Parameters to USB
3. Confirm or Cancel Save Parameters.

Once procedure is complete the display saves two files in a directory as follows:

My Computer > Removable Disk (USB Drive) > HMI > HMI000 >

- Parameter File: Recipe.csv
- Contact Information Recipe32.csv:

Load Parameters from USB

“Load Parameters” loads the current saved parameter settings off a USB Drive. This allows for easy transfer of unit parameters and contact information from one unit to another. Refer to parameter summary for list of parameters. Parameter files must be stored and named as follows:

My Computer > Removable Disk (USB Drive) > HMI > HMI000 >

- Parameter File: Recipe.csv
- Contact Information Recipe32.csv:

Instructions for Load Parameters:

1. Plug USB thumb drive into USB Port on Unit
2. Select Main Menu > Archives > Load Parameters to USB
3. Confirm or Cancel Load of Parameters.
4. Confirm or Cancel Load of Contact Information.

Specifications

General

Control

Dimensions: 9 21/64" x 6 21/64"

Electrical Ratings:

- Operating voltage:
24Vac (20 to 30 Vac, 60 Hz \pm 5%)
- Pump Relay Outputs:
120 Vac: 44.4 ALR, 7.4 Amps run
- Alarm Relay Output:
120 Vac: 6.3 ALR, 0.63 Amps run

Operating Temperature:

-4°F to 150°F (-20°C to 66°C)

Storage Temperature:

-40°F to 150°F (-40°C to 66°C).

Humidity: Up to 95% Relative Humidity, noncondensing at 104°F for 14 days. Condensing moisture may cause safety shutdown.

Vibration: to 0.5g Continuous (V2 level)

Sensors: All temperature sensors 10k NTC

NTC Sensors (temperature versus resistance).

Temp °C (°F)	10K NTC (kOhm) Beta of 3950
30 (-22)	176.08
20 (-4)	96.81
10 (14)	55.25
0 (32)	32.64
10 (50)	19.9
20 (68)	12.49
25 (77)	10
30 (86)	8.06
40 (104)	5.32
50 (122)	3.6
60 (140)	2.49
70 (158)	1.75
80 (176)	1.26
90 (194)	0.92
100 (212)	0.68
110 (230)	0.51
120 (248)	0.39

Display

4-inch Screen Dimensions:

- Bezel: 5.39" x 4.05" x 1.46"
- Panel Cutout: 4.68" x 3.65"

7-inch Screen Dimensions:

- Bezel: 8.46" x 6.33" x 1.96"
- Panel Cutout: 7.75" x 5.62"

Electrical Ratings:

- Operating voltage: DC +24V (-10% ~+15%)
(please use isolated power supply)
- **Power Consumption:** 5W

- **Backup Battery**

3V Lithium Battery CR2032, about 3 years operating life with power removed. Battery used to maintain time and date clock, not display memory.

Operating Temperature:

32°F ~ 140°F (0°C ~ 60°C)

Storage/Shipping Temperature:

-4°F ~ 140°F (-20°C ~ 60°C)

Humidity:

- 10% ~ 90% RH [0 ~ 40°C], 10% ~ 55% RH [41 ~ 50°C]

Vibration:

- IEC 61131-2 Compliant
- $5\text{Hz} \leq f < 9\text{Hz}$ = Continuous: 1.75mm / Occasional: 3.5mm
- $9\text{Hz} \leq f \leq 150\text{Hz}$ = Continuous: 0.5g / Occasional: 1.0g
- X, Y, Z directions for 10 times

Enclosure: NEMA 4/IP65.

Specifications

General

Replacement Parts

Listed in Table 13 are available replacement parts for the unit. These include temperature sensors, the control, display, and more. Part numbers are included to simplify the ordering process.

Part Number	Name	Description
112078-01	Residential Control	Residential/Light Commercial Unit Control, CSD-1 Compliant, Auto Temperature Control, 120 Vac Ignition Control, 2 Limit Monitoring Points, with Pre-purge and Post Purge, Safety Rated Temperature Limit, circulator relay outputs.
112078-10	Commercial Control	Commercial Concert Unit Control, CSD-1 Compliant, Auto Temperature Control, 120 Vac Ignition Control, 8 Limit Monitoring Points, with Pre-purge and Post Purge, Safety Rated Temperature Limit, PWM and 4-20mA dc Firing rate outputs, circulator relay outputs.
112077-01	4-inch Display	7-inch LCD Touch Screen Display, 24Vdc Power Supply, USB Connection, two RS485 Modbus ports
112077-02	7-inch Display	7-inch LCD Touch Screen Display, 24Vdc Power Supply, USB Connection, two RS485 Modbus ports
105686-01	Supply Sensor or Flue Gas Sensor	10k ohm, dual element, three wire, limit rated, thermistor type, temperature sensor, 6 inch lead wires, female Molex 0039014037 quick connector, 3/8 inch diameter.
105685-01	Return Sensor	10k ohm, single element, two wire thermistor type, temperature sensor, 6 inch lead wires, female Molex 0039013029 quick connector, 3/8 inch diameter.
101935-01	<u>Direct Immersion Type</u> DHW Sensor Header Sensor	10K ohm, single element, two wire thermistor type, Direct Immersion temperature sensor. Insertion is 1/2" NPT.
105685-01	<u>Thermowell Type</u> DHW Sensor Header Sensor	10K ohm, single element, two wire thermistor type, temperature sensor, suitable for insertion into thermowells. Thermowell not included.
105684-01	Thermowell	1/2"NPT Brass Immersion Well.
106035-01	Wireless Outdoor Sensor Kit	Wireless outdoor air reset adapter, includes wireless receiver module and wireless outdoor sensor. The receiver provides a wireless connection to the outdoor mounted sensor. Receiver is wired to the control's EnviraCOM terminals.
801SOL0012	Wired Outdoor Sensor	10k ohm, single element, two wire thermistor type, temperature sensor, outdoor air temperature sensor with weather proof box and protective sleeve.
106432-01	BACnet Universal Gateway Kit (includes gateway & manual)	Energy Management Systems (EMS) Universal Gateway translates Modbus 485 to BACnet MS/TP, BACnet/IP, Metasys N2 Open, or Modbus TCP. Compatible with Concert Unit Control, Apex Unit Control (ABC), Thermal Solutions Boiler Control (TSBC), Sage2.1 Control.
106433-01	LonWorks Universal Gateway Kit (includes gateway & manual)	Energy Management Systems (EMS) Universal Gateway translates Modbus 485 to LonWorks. Compatible with Concert Unit Control, Apex Boiler Control (ABC), Thermal Solutions Boiler Control (TSBC), Sage2.1 Control.
CR2032	Display Battery	3V Lithium Battery. Used to maintain time and date clock.

Table 13: Repair Parts

Specifications

Parameter Summary

USB	Parameter	Range	Security	Page
System Menu				
	Burner Enable	On/Off	Basic	32
X	Temperature Units	F / C	Basic	32
X	Outdoor Sensor Source	Not Installed / Modbus / Wired / Wireless	Basic	32
X	Outdoor Sensor Calibration	- 50 to 50 °	Basic	32
X	Antishort Cycle Time	0 - 20 minutes	Basic	32
X	CH Frost Protection	Enable / Disable	Basic	32
X	CH Frost Protection Setpoint	- 50 to 50 °F	Basic	32
X	Installer Password	none	Factory	33
X	Warm Weather Shutdown Enable	Enable / Disable	Basic	33
X	Warm Weather Shutdown Setpoint	20 to 100 °F	Basic	33
	System Date		Basic	33
	System Time		Basic	33
X	Auto Jump To Home Page	Enable / Disable	Basic	33
	Unit Brand	Thermal Solutions / Bryan Steam	Factory	33
Modulation Menu				
	Unit Type	NA	Factory	34
	CH Max Modulation Rate	(Min Mod Rate + 100) to Absolute Max Mod	Factory	34
	DHW Max Modulation Rate	(Min Mod Rate + 100) to Absolute Max Mod	Factory	34
	Minimum Modulation Rate	Absolute Min Mod to (CH Max Mod Rate - 100)	Factory	34
	Lightoff Rate	Min Modulation to Default Lightoff Rate	Factory	34
Operation Menu				
	Auto/Manual	Auto / Manual	Supervisor	30
	Rate	Min Mod Rate to CH Max Mod Rate	Supervisor	30
Pump Menu				
X	System Pump	Never / Any Demand / Central heat, No Priority / Central Heat Optional Priority / Fresh Air Damper	Supervisor	35
X	Primary Pump	Never / Any Demand / Central Heat, Off DHW	Supervisor	35
X	DHW Pump	Never / Primary loop Piped IWH / Boiler Piped IWH / Fresh Air Damper	Supervisor	35
X	CH pump overrun time	0 to 60 minutes	Supervisor	36
X	DHW pump overrun time	0 to 60 minutes	Supervisor	36
X	Primary pump overrun time	0 to 60 minutes	Supervisor	36
X	Pump exercise interval	0 to 40 days	Supervisor	36
X	Pump exercise time	0 to 600 seconds	Supervisor	36
Central Heat Menu				
X	CH Setpoint	50 to 190 °F	Basic	38
X	CH TOD Setback Setpoint	50 to 190 °F	Basic	38
X	CH Difference Above	3 to 29 °F	Basic	38
X	CH Difference Below	3 to 29 °F	Basic	38
X	CH Response Speed	1 to 5	Supervisor	38
X	CH Modulation Sensor	Outlet Sensor / Header Sensor	Supervisor	39
X	Central Heat Low Fire Hold Time	0 to 30 minutes	Supervisor	39
X	Central Heat Low Fire Hold Rate	Absolute Min Mod to Lightoff Rate Default	Supervisor	39
Domestic Hot Water Menu				
X	DHW Priority Time	0 to 90 minutes	Basic	39
X	DHW Setpoint	50 to 190 °F	Basic	39
X	DHW TOD Setback Setpoint	50 to 190 °F	Basic	39
X	DHW Difference Below	3 to 29 °F	Basic	39
X	DHW Difference Above	3 to 29 °F	Basic	39
X	DHW Response Speed	1 to 5	Supervisor	40
X	Domestic Low Fire Hold Time	0 to 30 minutes	Supervisor	40
X	Domestic Low Fire Hold Rate	Absolute Min	Supervisor	40
X	DHW Demand/Modulation	DHW Switch & Outlet Sensor / DHW Sensor & DHW Sensor	Basic	40
Outdoor Reset Menu				
X	Outdoor Reset Enable/Disable	Enable / Disable	Basic	41
X	Minimum Outdoor Temperature	- 50 to 32 °F	Basic	41
X	Maximum Outdoor Temperature	35 to 100 °F	Basic	41

USB	Parameter	Range	Security	Page
X	Low Water Temperature	70 to 180 °F	Basic	41
X	Minimum Boiler Water Temperature	50 to 185 °F	Basic	41
X	Boost Time	0 to 30 minutes	Basic	41
X	Central Heat ODR Max Off Point	50 to 190 °F	Basic	41
X	Lead Lag CH ODR Max Off Point	50 to 190 °F	Basic	41
Sequence Master Menu				
	Master Enable/Disable	Disable / Enabled	Supervisor	42
	Base Load Common Rate	25 to 100 %	Supervisor	42
	Indirect Water Heater	Boiler Piped / Primary Piped	Supervisor	42
	Unit Start Delay	0.5 to 20 minutes	Supervisor	42
	DHW Two Boiler Start	Enable / Disable	Supervisor	42
	Stop All Units	50 to 195 °F	Basic	42
	Unit Stop Delay	0.5 to 5 minutes	Supervisor	42
	Lead Rotation Time	8 to 48 hours	Basic	42
	LL Response Speed	0 to 5	Supervisor	42
Slave Sequencer Menu				
	Slave Selection Order	First / Normal / Last	Supervisor	43
	Unit Address	1 to 8	Supervisor	43
Limits Menu				
X	Stepped Modulation Start Offset	(Stepped Modulation Recycle Offset + 6) - 30	Factory	43
X	Stepped Modulation Recycle Offset	10 - (Stepped Modulation Start Offset - 6)	Factory	43
X	Preferred Stack Limit Setpoint	150 °F to Stack Default Limit	Factory	43
X	Preferred Outlet Limit Setpoint	60 °F to Outlet Default Limit	Factory	43
EMS Remote Demand Menu				
	Modulation Source	Local / 4 - 20mAadc / Modbus	Supervisor	22
	CH Demand Switch	Local / Modbus	Supervisor	22
	LL Demand Switch	Local / Modbus	Supervisor	22
	4mA Water Temp	50 to 185 °F	Supervisor	22
	Lead Lag Setpoint Source	Local / 4 - 20mAadc / Modbus	Supervisor	22
	Central Heat Setpoint Source	Local / 4 - 20mAadc / Modbus	Supervisor	22
	20mA Water Temp	50 to 185 °F	Supervisor	22
	Analog Input Hysteresis	0 to 10	Supervisor	23
	Analog output hysteresis	0 to 40	Supervisor	23
	Analog Rate Tracking	Disable / PWM to 4 - 20mA / PWM to 0 - 10V / LL Rate to 4 - 20mA / LL Rate to 0 - 10V	Supervisor	22
Fan Tune Menu				
X	Fan speed - up ramp	0 to 12000	Supervisor	47
X	Fan slow - down ramp	0 to 12000	Supervisor	47
X	Fan gain up	1 to 100	Factory	47
X	Fan gain down	1 to 100	Factory	47
X	CH slow start enable/disable	Enable - Disable	Supervisor	47
X	DHW slow start enable/disable	Enable - Disable	Supervisor	47
X	Slow start ramp	0 to 1000 rpm	Supervisor	47
X	Slow start degrees	0 °F to 180	Supervisor	47

NOTES

“Load Parameters” loads the current saved parameter settings off a USB Drive. This allows for easy transfer of unit parameters and contact information from one unit to another.

This image shows a single sheet of white paper with horizontal blue or grey ruling lines, typical of notebook paper. The lines are evenly spaced and run across the width of the page. There are no margins, text, or other markings on the paper.



1175 Manheim Pike
Lancaster PA 17601
Telephone 717-239-7642
Fax 877-501-5212
www.ThermalSolutions.com



783 N Chili Ave
Peru IN 46970
Telephone 765-473-6651
Fax 765-473-3074
www.bryanboilers.com



2930 Old Tree Drive
Lancaster PA 17603
Telephone 717-397-4701
Fax 866-855-6078
www.usboiler.net